

# **Illuminazione / Beleuchtung**

## Strisce LED

629	Lynx Premium (12V DC)
632	Lynx Premium COB (12V DC)
633	Lynx Premium RGB (12V DC)
634	Lynx Basic (12V DC)
636	Connettori Lynx (12V DC)
640	Lynx Premium (24V DC)
641	Lynx Premium COB (24V DC)
643	Neonlynx (24V DC)
646	Connettori Lynx (24V DC)
651	Sensori Lynx (12V DC) (24V DC)
653	Profili Lynx W
656	Profili Lynx

## Illuminazioni LED

663	Illuminazione per cassette
665	Specchi illuminati
670	Illuminazioni da bagno
673	Batteria
677	Barra pensile con illuminazione
679	Lampade
681	Punti luce

## Convertitori e sensori

686	Convertitori
688	Sensori
695	Controllori per luci LED
699	Interruttori
698	Cavi

## Ufficio

701	Cariaca batterie
705	Connettori
714	Passacavi
716	Supporti per TV
718	Guide porta tastiera

## LED-Streifen

629	Lynx Premium (12V DC)
632	Lynx Premium COB (12V DC)
633	Lynx Premium RGB (12V DC)
634	Lynx Basic (12V DC)
636	Lynx-Anschlüsse (12V DC)
640	Lynx Premium (24V DC)
641	Lynx Premium COB (24V DC)
643	Neonlynx (24V DC)
646	Lynx-Anschlüsse (24V DC)
651	Lynx-Sensoren (12V DC) (24V DC)
653	Lynx W-Profile
656	Lynx-Profile

## LED Lichter

663	Schubladen-Leuchten
665	Beleuchtete Spiegel
670	Badezimmerleuchten
673	Mit Batterie
677	Beleuchtete Hängestangen
679	Beleuchtung
681	Spot

## Wandler und sensoren

686	Wandler
688	Sensoren
695	LED-Lichtsteuerungen
699	Schalter
698	Kabel

## Büro

701	Induktionsbatterie
705	Anschlüsse
714	Kabelführung
716	TV-Ständer
718	Tastaturhalterung-Führungsschiene

## Informazioni generali / Allgemeine Informationen



Il prodotto è conforme alle direttive europee: LVD 2014-35-EU, EMC 2014-30-EU e RoHS 2011/65/EU.  
Das Produkt entspricht den europäischen Richtlinien: LVD 2014-35-EU, EMC 2014-30-EU und RoHS 2011/65/EU.

Isolamento in cui la protezione contro le scosse elettriche è garantita dall'isolamento principale e da un conduttore di protezione collegato a terra.	Isolamento di Classe II protetto contro le scosse elettriche da contatto diretto e indiretto. Non è richiesto il collegamento a terra.	Apparecchi a bassissima tensione di classe III. Gli apparecchi a bassissima tensione non devono essere collegati a conduttori di terra.
Isolierung, bei der der Schutz gegen elektrischen Schlag durch die Hauptisolierung und einen schutzgeerdeten Leiter gewährleistet ist.	Isolierung der Klasse II zum Schutz gegen Stromschlag bei direktem und indirektem Kontakt. Es ist kein Erdungsanschluss erforderlich.	Geräte der Schutzklasse III für sehr niedrige Spannungen. Geräte mit sehr niedriger Spannung dürfen nicht an geerdete Leiter angeschlossen werden.
Adatto per il montaggio su superfici di materiali di cui non si conoscono le caratteristiche di infiammabilità (ad es. legno).	Applicare l'apparecchio per l'installazione in o su superfici normalmente infiammabili.	Per proteggere l'ambiente, a fine vita non smaltire l'apparecchio in un contenitore, ma portarlo negli appositi punti di raccolta previsti dalla legge.
Geegnet für die Montage auf Oberflächen aus Materialien, deren Entflammbarkeitsseigenschaften nicht bekannt sind (z. B. Holz).	Geegnet für die Installation in oder auf normal entflammbaren Oberflächen.	Zum Schutz der Umwelt darf die Leuchte am Ende ihrer Lebensdauer nicht in einem Container entsorgt werden, sondern muss bei den gesetzlich vorgesehenen Sammelstellen abgegeben werden.

## Convertitori / Konverter

Un'aggiunta essenziale alla vostra installazione sono i convertitori di potenza per le luci LED.

6W	5211020
15W	521120
30W	5147420
50W	5147520
72W	5008520
100W	5209320
200W	5209420

**AC 230V  
50Hz**

Gli apparecchi che funzionano a 230V AC non hanno bisogno di un convertitore.  
Leuchten, die mit 230V Wechselstrom arbeiten, benötigen keinen Konverter.

Eine wesentliche Ergänzung Ihrer Installation sind die Stromkonverter für Ihre LED-Leuchten.

15W	5211220
30W	5147620
50W	5147720
100W	5209520

**5V DC**

Apparecchi dotati di batteria ricaricabile con caricatore mobile da 5V DC.  
Leuchten mit wiederaufladbarem Akku mit einem 5V DC Ladegerät.

## Sensori / Sensoren

<p><b>Sensore interruttore a scomparsa / Sensor-Schalter verdeckt</b></p> <p>Sistema di rilevamento di prossimità a scomparsa, che accende o spegne l'apparecchio quando il suo campo di rilevamento viene disturbato. Senza timer.</p> <p>Verdecktes Näherungserkennungssystem, das die Leuchte ein- oder ausschaltet, wenn ihr Erfassungsbereich beeinträchtigt wird. Ohne Zeitschaltuhr.</p>	<p><b>Sensore interruttore / Schalter Sensor</b></p> <p>Sistema di rilevamento di prossimità che accende o spegne l'apparecchio quando il suo campo di rilevamento è disturbato. Senza timer.</p> <p>Näherungserkennungssystem, das die Leuchte ein- oder ausschaltet, wenn ihr Erfassungsbereich beeinträchtigt wird. Ohne Zeitschaltuhr.</p>	<p><b>Sensore di prossimità / Näherungssensor</b></p> <p>Sistema di rilevamento di prossimità per porte che mantiene l'apparecchio acceso e lo spegne solo quando il suo campo di rilevamento è disturbato. Senza timer.</p> <p>Näherungserkennungssystem für Türen, das die Leuchte eingeschaltet lässt und nur dann ausschaltet, wenn ihr Erfassungsbereich beeinträchtigt wird. Ohne Zeitschaltuhr.</p>	<p><b>Sensore di movimento / Bewegungsmelder</b></p> <p>Sistema di rilevamento del movimento che accende l'apparecchio quando il suo campo di rilevamento viene disturbato. È dotato di un timer per lo spegnimento dell'apparecchio.</p> <p>Bewegungserkennungssystem, das die Leuchte einschaltet, wenn ihr Erfassungsbereich beeinträchtigt wird. Und es verfügt über einen Timer zum Ausschalten der Leuchte.</p>	<p><b>Sensore di contatto / Berührungssensor</b></p> <p>Sistema di rilevamento a contatto, che accende l'apparecchio al tocco. Il campo di rilevamento e/o il funzionamento sono regolabili in base alle esigenze.</p> <p>Kontakterkennungssystem, das die Leuchte einschaltet. Der Erfassungsbereich und/oder der Betrieb ist je nach Bedarf einstellbar.</p>	<p><b>Sensore interruttore / Schalter Sensor</b></p> <p>Sistema di controllo remoto a radiofrequenza che accende l'apparecchio. Dispone anche di un timer per spegnere l'apparecchio.</p> <p>Radiofrequenz-Fernbedienungssystem, das die Leuchte einschaltet. Es verfügt auch über einen Timer zum Ausschalten der Leuchte.</p>	<p><b>Sensore di vibrazione / Vibrationssensor</b></p> <p>Sistema che rileva le vibrazioni del cassetto quando viene aperto e accende l'apparecchio, per poi spegnerlo automaticamente grazie al timer.</p> <p>System, das die Vibration des Schubkastens beim Öffnen erfasst und die Leuchte ein- und mit Hilfe eines Zeitschalters automatisch ausschaltet.</p>

Temperatura di colore / Farbtemperatur

KELVIN

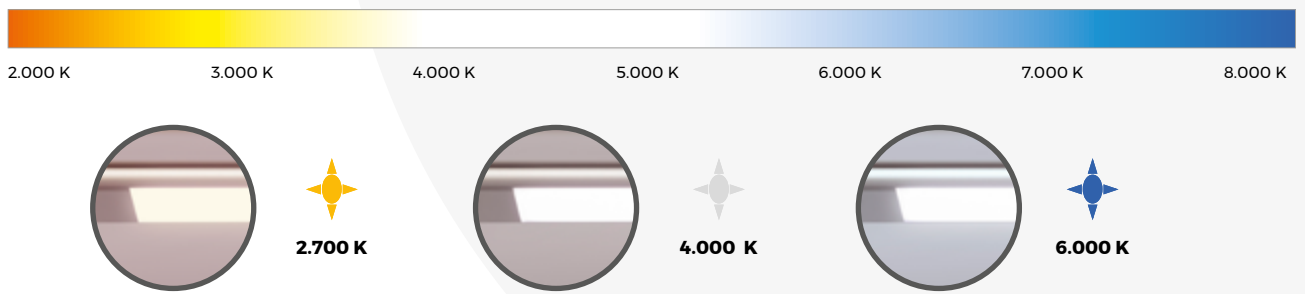

Grado di protezione / Schutzgrad

IP **X** **X**

0	0	
1	1	
2	2	
3	3	
4	4	
5	5	
6	6	
	7	
	8	

IP **X** **X**

Grado di protezione contro i solidi / Schutzgrad gegen Feststoffe      Grado di protezione contro i liquidi / Schutzgrad gegen Flüssigkeiten

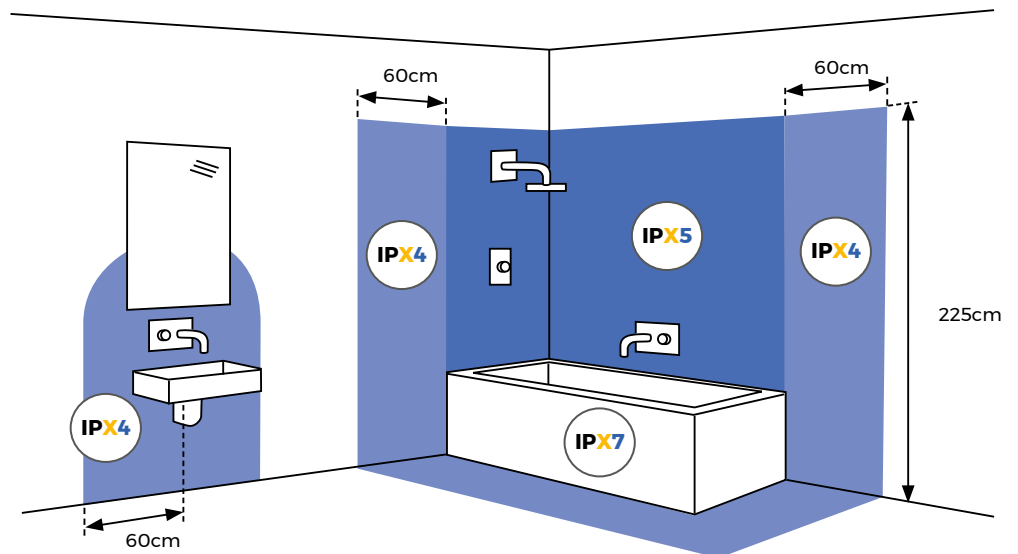

Imballaggio delle strisce LED / Verpackung der LED-Streifen



In linea con il nostro impegno per la sostenibilità, stiamo cambiando l'imballaggio delle strisce LED da plastica a cartone. Continuiamo il nostro percorso verso un'industrializzazione inclusiva e sostenibile. L'SDG 12 (Sustainable Development Goals) si concentra sulla promozione dell'efficienza nell'uso delle risorse naturali, come il cartone in questo caso, per ridurre l'impatto ambientale dei nostri progetti.

Im Rahmen unseres Engagements für Nachhaltigkeit stellen wir die Verpackung von LED-Streifen von Kunststoff auf Karton um. Wir setzen unseren Weg zu einer integrativen und nachhaltigen Industrialisierung fort. SDG 12 (Sustainable Development Goals) konzentriert sich auf die Förderung der Effizienz bei der Nutzung natürlicher Ressourcen, wie in diesem Fall Karton, um die Umweltauswirkungen unserer Projekte zu verringern.

# Strisce LED LED-Streifen

Di cosa ho bisogno per un'installazione?  
Was benötige ich für eine Installation?

- 1
- 2
- 3
- 4

1

Una striscia LED / Einen LED-Streifen

Le strisce LED da 12 V DC sono ideali per l'utilizzo in installazioni di mobili o di breve lunghezza, dove è necessario un adattamento più preciso.

12-V-DC-LED-Streifen sind ideal für den Einsatz in Möbeln oder kurzen Installationen, bei denen eine genauere Passform erforderlich ist.



12V DC

Lynx Premium 12V DC

Lynx Basic 12V DC



24V DC

Lynx Premium 24V DC

Le strisce LED da 24 V DC sono perfette per l'uso in installazioni commerciali lunghe, grazie alle loro migliori prestazioni in queste situazioni.

24V DC LED-Streifen sind aufgrund ihrer besseren Leistung in diesen Situationen perfekt für den Einsatz in langen kommerziellen Installationen.

2

Un cavo o un sensore / Ein Kabel oder Sensor

Lynx 24V DC



24V DC

Lynx 12V DC



12V DC



12V DC



24V DC

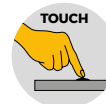

TOUCH



MOTION

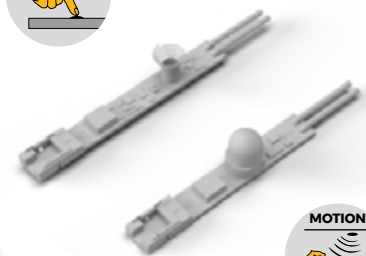
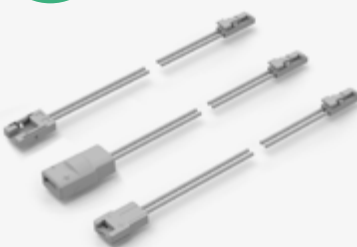

### 3

Un convertitore / Ein Konverter

Convertitore per apparecchi o dispositivi funzionanti a corrente continua a 12 V DC.

Konverter für Leuchten oder Geräte, die mit Gleichstrom betrieben werden, auf 12 V DC.



**12V DC**

6W	5211020
15W	5211120
30W	5147420
50W	5147520
72W	5008520
100W	5209320
200W	5209420

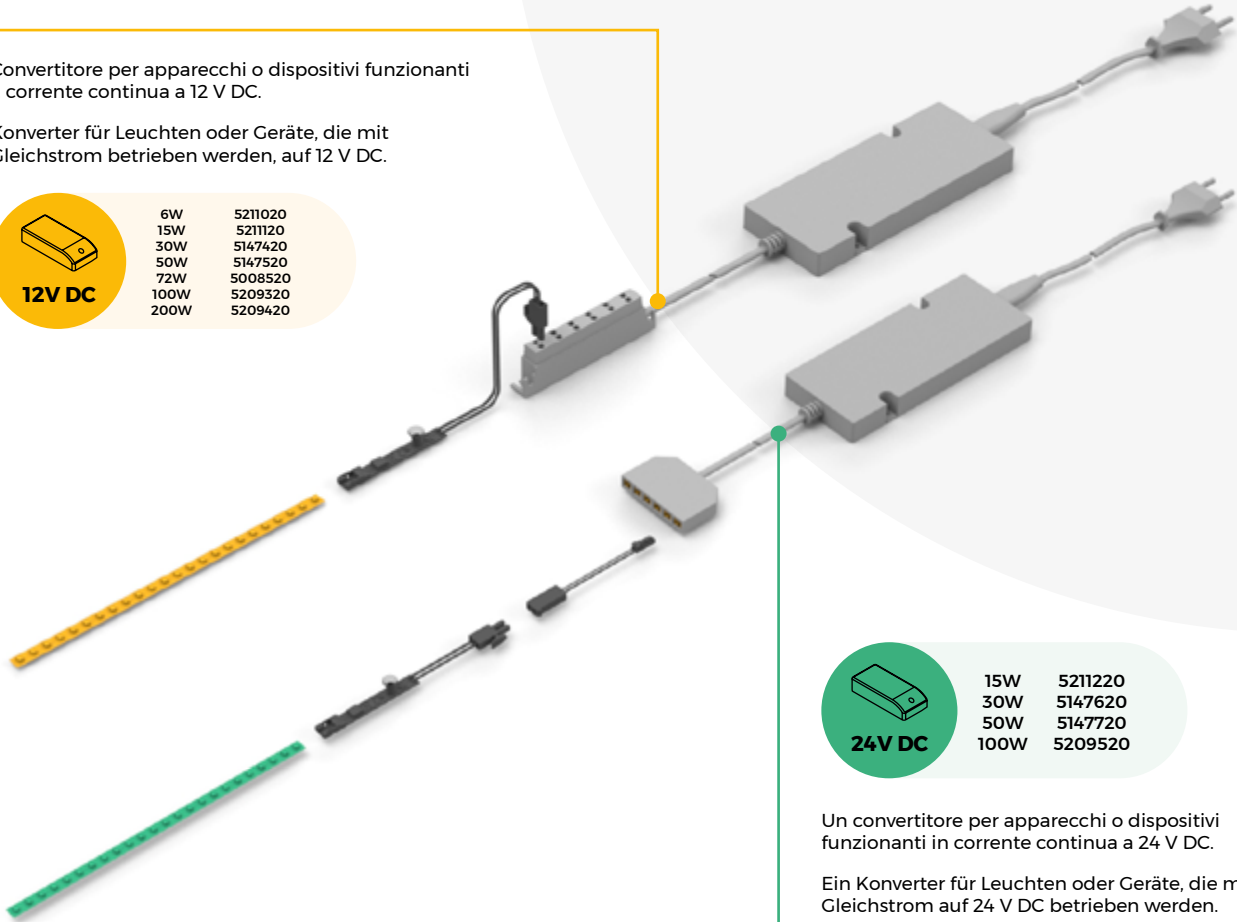

**24V DC**

15W	5211220
30W	5147620
50W	5147720
100W	5209520

Un convertitore per apparecchi o dispositivi funzionanti in corrente continua a 24 V DC.

Ein Konverter für Leuchten oder Geräte, die mit Gleichstrom auf 24 V DC betrieben werden.

### 4

Un profilo per il vostro apparecchio / Ein Profil für Ihre Leuchte

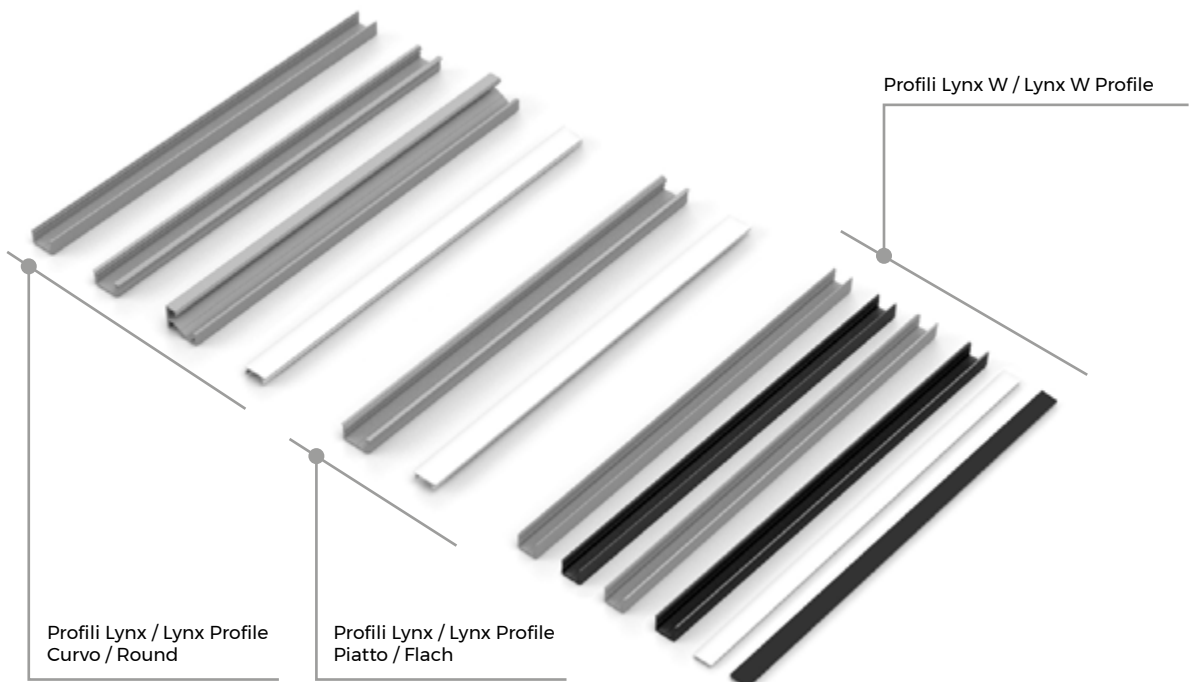

Profili Lynx / Lynx Profile  
Curvo / Round

Profili Lynx / Lynx Profile  
Piatto / Flach

Profili Lynx W / Lynx W Profile

## Strisce LED Lynx Premium 12V DC LED-Streifen Lynx Premium 12V DC

Le strisce LED Lynx Premium sono progettate per installazioni in cui è richiesto un uso intensivo, in quanto hanno una buona efficienza e prestazioni elevate.

Lynx Premium LED-Streifen wurden für Installationen entwickelt, bei denen eine intensive Nutzung erforderlich ist, da sie eine gute Effizienz und hohe Leistung aufweisen.

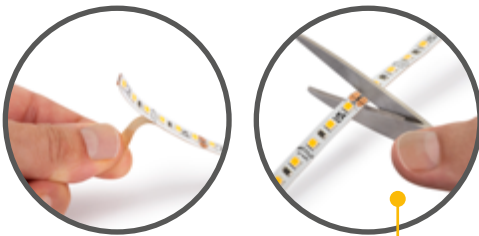

6W	5211020
15W	5211120
30W	5147420
50W	5147520
72W	5008520
100W	5209320
200W	5209420

Il nastro adesivo 3M® 300LSE garantisce la migliore adesione.

Das 3M® 300LSE Klebeband bietet die beste Haftung.

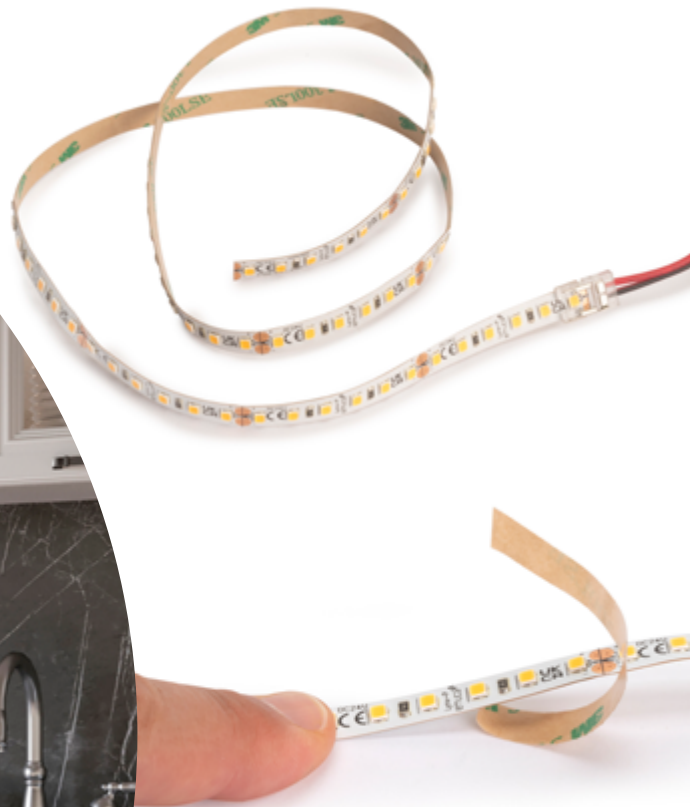

Striscia LED Lynx Premium 4,8W/m IP20 (12V DC)  
LED Streifen Lynx Premium 4,8W/m IP20 (12V DC)

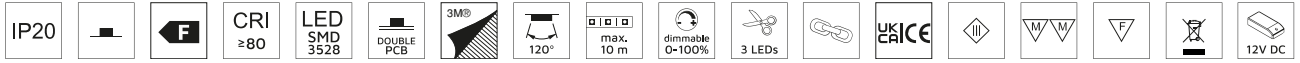

L	Efficienza/Effizienz	Lumen	Potenza/Leistung	Temperatura di colore/Farbtemperatur	LEDs	Finitura/Fertigstellung	Imballaggio/Verpackung	Cod.
5 m	112 lm / W	539 lm / m	4,8 W / m	Bianco freddo 6.000 K/ Kaltweiß 6.000 K	60 LEDs / m	Non classificata/ Nicht bestimmt	2 UN/Einh	5220420
10 m	114 lm / W	546 lm / m	4,8 W / m	Bianco naturale 4.000 K/ Naturweiß 4.000 K	60 LEDs / m	Non classificata/ Nicht bestimmt	1 UN/Einh	5220520
5 m	109 lm / W	525 lm / m	4,8 W / m	Bianco caldo 3.000 K/ Warmweiß 3.000 K	60 LEDs / m	Non classificata/ Nicht bestimmt	2 UN/Einh	5220620

Tecnoplastica/Kunststoff

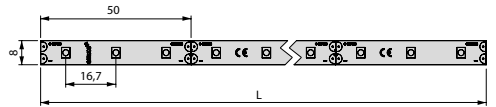
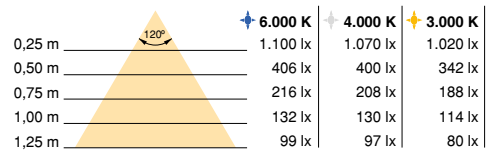

Striscia LED Lynx Premium 9,6W/m IP20 (12V DC)  
LED Streifen Lynx Premium 9,6W/m IP20 (12V DC)



L	Efficienza/Effizienz	Lumen	Potenza/Leistung	Temperatura di colore/Farbtemperatur	LEDs	Finitura/Fertigstellung	Imballaggio/Verpackung	Cod.
5 m	119 lm / W	1.138 lm / m	9,6 W / m	Bianco freddo 6.000 K/ Kaltweiß 6.000 K	120 LEDs / m	Non classificata/ Nicht bestimmt	2 UN/Einh	5210020
50 m	119 lm / W	1.138 lm / m	9,6 W / m	Bianco freddo 6.000 K/ Kaltweiß 6.000 K	120 LEDs / m	Non classificata/ Nicht bestimmt	1 UN/Einh	5215420
10 m	110 lm / W	1.053 lm / m	9,6 W / m	Bianco naturale 4.000 K/ Naturweiß 4.000 K	120 LEDs / m	Non classificata/ Nicht bestimmt	1 UN/Einh	5210120
50 m	110 lm / W	1.053 lm / m	9,6 W / m	Bianco naturale 4.000 K/ Naturweiß 4.000 K	120 LEDs / m	Non classificata/ Nicht bestimmt	1 UN/Einh	5215520
5 m	106 lm / W	1.018 lm / m	9,6 W / m	Bianco caldo 3.000 K/ Warmweiß 3.000 K	120 LEDs / m	Non classificata/ Nicht bestimmt	2 UN/Einh	5210220
50 m	106 lm / W	1.018 lm / m	9,6 W / m	Bianco caldo 3.000 K/ Warmweiß 3.000 K	120 LEDs / m	Non classificata/ Nicht bestimmt	1 UN/Einh	5215620

Tecnoplastica/Kunststoff

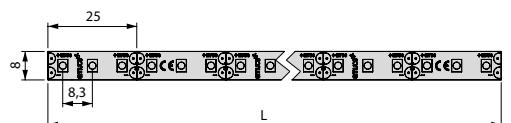
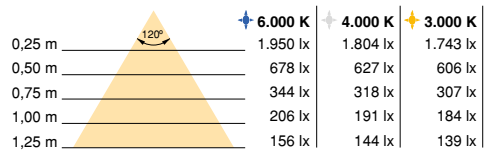
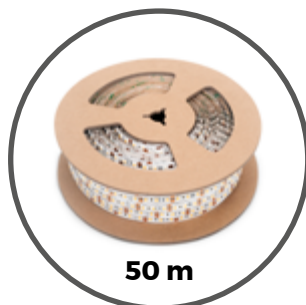



**Striscia LED Lynx Premium 9,6W/m IP65 (12V DC)**  
**LED Streifen Lynx Premium 9,6W/m IP65 (12V DC)**



L	Efficienzia/Effizienz	Lumen	Potenza/Leistung	Temperatura di colore/Farbtemperatur	LEDs	Finitura/Fertigstellung	Imballaggio/Verpackung	Cod.
10 m	101 lm / W	969 lm/m	9,6 W / m	Bianco freddo 6.000 K/ Kaltweiß 6.000 K	120 LEDs / m	Non classificata/ Nicht bestimmt	1 UN/Einh	5210720
5 m	97 lm / W	932 lm / m	9,6 W / m	Bianco caldo 3.000 K/ Warmweiß 3.000 K	120 LEDs / m	Non classificata/ Nicht bestimmt	2 UN/Einh	5210820

Tecnoplastica/Kunststoff

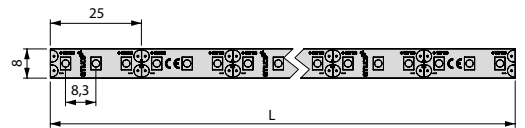
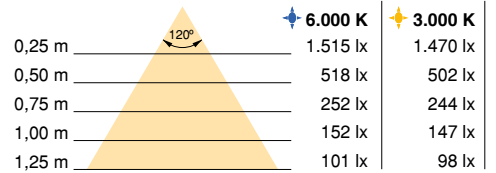

**Striscia LED Lynx Premium 14,4W/m IP20 (12V DC)**  
**LED Streifen Lynx Premium 14,4W/m IP20 (12V DC) (12V DC)**



L	Efficienzia/Effizienz	Lumen	Potenza/Leistung	Temperatura di colore/Farbtemperatur	LEDs	Finitura/Fertigstellung	Imballaggio/Verpackung	Cod.
5 m	121 lm / W	1.742 lm / m	14,4 W / m	Bianco freddo 6.000 K/ Kaltweiß 6.000 K	60 LEDs / m	Non classificata/ Nicht bestimmt	2 UN/Einh	5209620
5 m	140 lm / W	2.016 lm / m	14,4 W / m	Bianco naturale 4.000 K/ Naturweiß 4.000 K	60 LEDs / m	Non classificata/ Nicht bestimmt	2 UN/Einh	5209720
5 m	138 lm / W	1.988 lm / m	14,4 W / m	Bianco caldo 3.000 K/ Warmweiß 3.000 K	60 LEDs / m	Non classificata/ Nicht bestimmt	2 UN/Einh	5209820

Tecnoplastica/Kunststoff

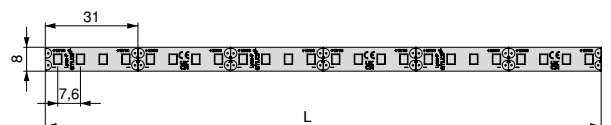
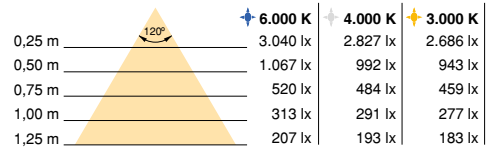

**Striscia LED Lynx Premium 14,4W/m IP65 (12V DC)**  
**LED Streifen Lynx Premium 14,4W/m IP65 (12V DC) (12V DC)**

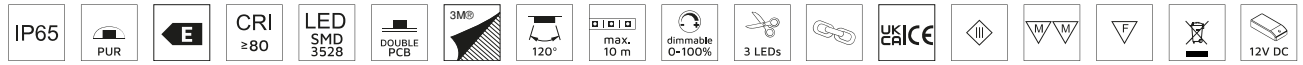

L	Efficienza/ Effizienz	Lumen	Potenza/ Leistung	Temperatura di colore/ Farbtemperatur	LEDs	Finitura/Fertigstellung	Imballaggio/ Verpackung	Cod.
5 m	126 lm / W	1.808 lm / m	14,4 W / m	Bianco naturale 4.000 K/ Naturweiß 4.000 K	60 LEDs / m	Non classificata/ Nicht bestimmt	2 UN/Einh	5209920

Tecnoplastica/Kunststoff

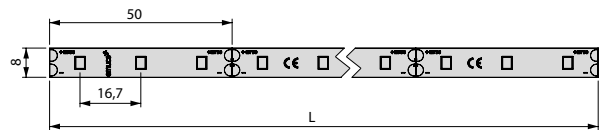
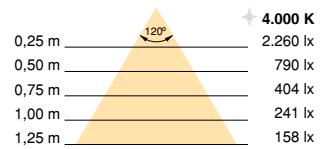

**Kit di strisce LED Lynx Premium 9,6W/m IP20 (12V DC)**  
**LED-Streifen-Bausatz Lynx Premium 9,6W/m IP20 (12V DC)**

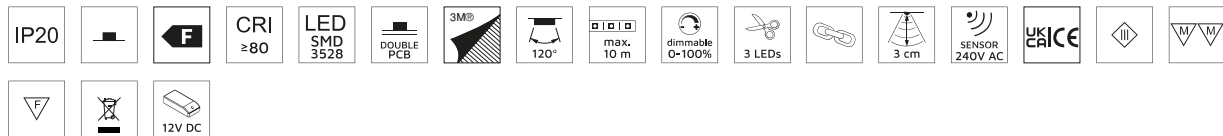

Descrizioni/Beschreibung	Finitura/Fertigstellung	Imballaggio/Verpackung	Cod.
DOOR	Non classificata/Nicht bestimmt	1 UN/Einh	5049020
SWITCH	Non classificata/Nicht bestimmt	1 UN/Einh	5049120

Tecnoplastica/Kunststoff



Il kit comprende tutto il necessario per l'installazione: una striscia LED Lynx Premium 9,6W/m IP20 da 5 m, 2 cavi H, 2 convertitori da 30W (12V DC) e 2 sensori (a seconda del modello).

Dieses Kit enthält alles, was für die Installation benötigt wird: einen 5 m langen Lynx Premium 9,6 W/m IP20 LED-Streifen, 2 H-Kabel, 2 30 W-Konverter (12 V DC) und 2 Sensoren (je nach Modell).

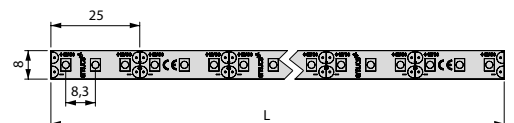
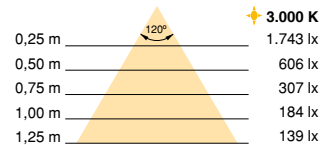
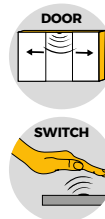

## Strisce LED Lynx Premium COB 12V DC LED-Streifen Lynx Premium COB 12V DC

La striscia LED Lynx Premium COB è progettata con una linea continua nota come Chip On Board, che genera una luce LED uniforme e senza punti.

Der Lynx Premium COB LED-Streifen ist mit einer durchgehenden Linie ausgestattet, die als Chip On Board bekannt ist und ein gleichmäßiges, punktfreies LED-Licht erzeugt.

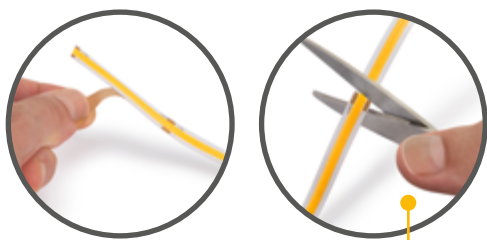

6W 5211020  
15W 5211120  
30W 5147420  
50W 5147520  
72W 5008520  
100W 5209320  
200W 5209420

Si distingue per l'elevata luminosità e la continuità della luce.

Es zeichnet sich durch seine hohe Helligkeit und Kontinuität des Lichts aus.



### Lynx Premium COB 4,8 W/m IP20 (12V DC)

#### LED Streifen Lynx Premium COB 4,8 W/m IP20 (12V DC)

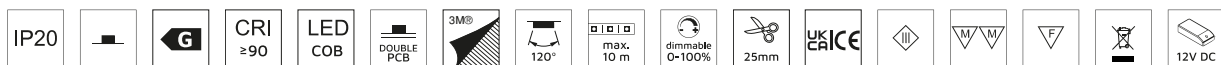

L	Efficienza/Efficienz	Lumen	Potenza/Leistung	Temperatura di colore/ Farbtemperatur	LEDs	Finitura/Fertigstellung	Imballaggio/Verpackung	Cod.
10 m	104 lm / W	501 lm / m	4,8 W / m	Bianco freddo 6.000 K/ Kaltweiß 6.000 K	320 LEDs / m	Non classificata/ Nicht bestimmt	1 UN/Einh	5220720
50 m	104 lm / W	501 lm / m	4,8 W / m	Bianco freddo 6.000 K/ Kaltweiß 6.000 K	320 LEDs / m	Non classificata/ Nicht bestimmt	1 UN/Einh	5220820

Tecnoplastica/Kunststoff



Distance	Beam Angle	Illuminance
0,25 m	120°	865 lx
0,50 m		370 lx
0,75 m		210 lx
1,00 m		146 lx
1,25 m		102 lx

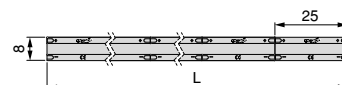

Striscia LED Lynx Premium RGB 14,4W/m IP65 (12V DC)  
LED Streifen Lynx Premium RGB 14,4W/m IP65 (12V DC)

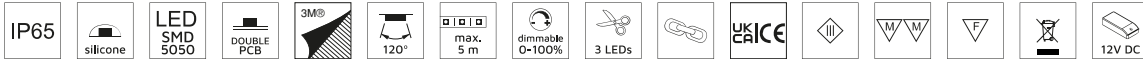

L	Efficienza/Effici- enzia	Lumen	Potenza/Leis- tung	Temperatura di colo- re/Farbtemperatur	LEDs	Finitura/Fertigstellung	Imballaggio/ Verpackung	Cod.
5 m	67 lm / W	960 lm / m	14,4 W / m	RGB/RGB	60 LEDs / m	Non classificata/ Nicht bestimmt	1 UN/Einh	5200020

Tecnoplastica/Kunststoff

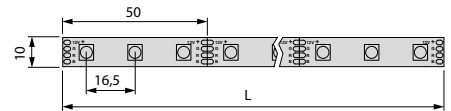
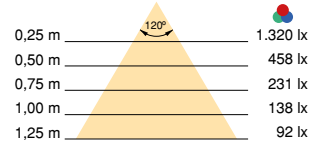
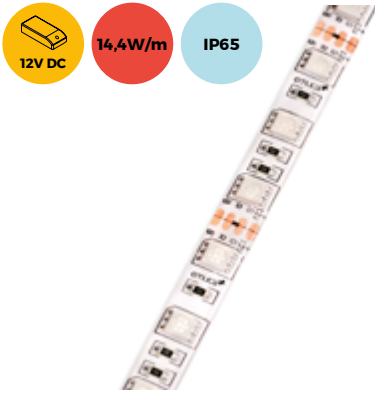

Cavo RGB (12V DC)  
RGB-Kabel für LED Streifen (12V DC)

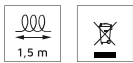

Potenza/Leistung	Input	Output	Finitura/Fertigstellung	Imballaggio/Verpackung	Cod.
36W	12V DC	12V DC	Non classificata/Nicht bestimmt	5 UN/Einh	5020620

Tecnoplastica/Kunststoff

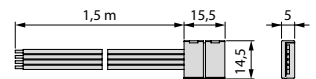

Connettore RGB (12V DC)  
Verbinder RGB (12V DC)



Potenza/Leistung	Input	Output	Finitura/Fertigstellung	Imballaggio/Verpackung	Cod.
36W/72W	12/24V DC	12/24V DC	Non classificata/Nicht bestimmt	5 UN/Einh	5020920

Tecnoplastica/Kunststoff

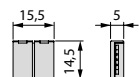

Striscia LED Lynx Basic 4,8W/m IP20 (12V DC)  
LED Streifen Lynx Basic 4,8W/m IP20 (12V DC)

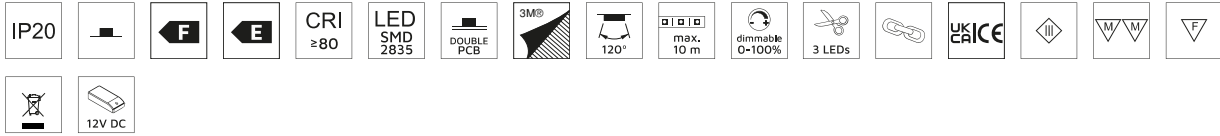

L	Efficienza/ Effizienz	Lumen	Potenza/Leis- tung	Temperatura di colore/ Farbtemperatur	LEDs	Finitura/Fertigstellung	Imballaggio/ Verpackung	Cod.
5 m	E (133 lm / W)	637 lm / m	4,8 W / m	Bianco freddo 6.000 K/ Kaltweiß 6.000 K	60 LEDs / m	Non classificata/ Nicht bestimmt	2 UN/Einh	5213120
5 m	E (122 lm / W)	589 lm / m	4,8 W / m	Bianco naturale 4.000 K/ Naturweiß 4.000 K	60 LEDs / m	Non classificata/ Nicht bestimmt	2 UN/Einh	5215720
5 m	F (121 lm / W)	584 lm / m	4,8 W / m	Bianco caldo 3.000 K/ Warmweiß 3.000 K	60 LEDs / m	Non classificata/ Nicht bestimmt	2 UN/Einh	5213220

Tecnoplastica/Kunststoff

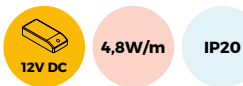

	6.000 K	4.000 K	3.000 K
0,25 m	1.510 lx	1.480 lx	1.470 lx
0,50 m	625 lx	613 lx	600 lx
0,75 m	358 lx	351 lx	352 lx
1,00 m	222 lx	218 lx	220 lx
1,25 m	160 lx	157 lx	152 lx

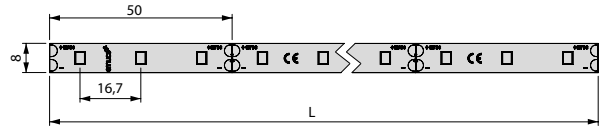

Striscia LED Lynx Basic 9,6W/m IP20 (12V DC)  
LED Streifen Lynx Basic 9,6W/m IP20 (12V DC)

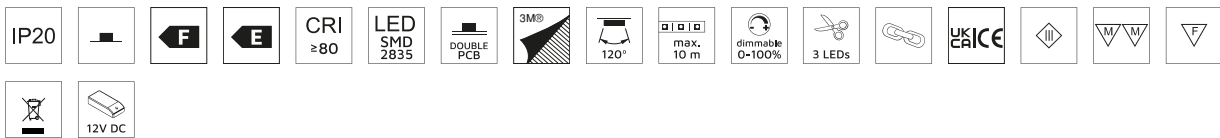

L	Efficienza/ Effizienz	Lumen	Potenza/Leis- tung	Temperatura di colore/ Farbtemperatur	LEDs	Finitura/Fertigstellung	Imballaggio/ Verpackung	Cod.
5 m	E (119 lm / W)	1.140 lm / m	9,6 W / m	Bianco freddo 6.000 K/ Kaltweiß 6.000 K	120 LEDs / m	Non classificata/ Nicht bestimmt	2 UN/Einh	5213320
5 m	E (124 lm / W)	1.195 lm / m	9,6 W / m	Bianco naturale 4.000 K/ Naturweiß 4.000 K	120 LEDs / m	Non classificata/ Nicht bestimmt	2 UN/Einh	5215820
5 m	F (118 lm / W)	1.138 lm / m	9,6 W / m	Bianco caldo 3.000 K/ Warmweiß 3.000 K	120 LEDs / m	Non classificata/ Nicht bestimmt	2 UN/Einh	5214720

Tecnoplastica/Kunststoff

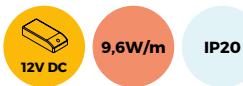

	6.000 K	4.000 K	3.000 K
0,25 m	2.480 lx	2.406 lx	2.760 lx
0,50 m	990 lx	960 lx	825 lx
0,75 m	565 lx	548 lx	498 lx
1,00 m	354 lx	343 lx	268 lx
1,25 m	256 lx	248 lx	200 lx

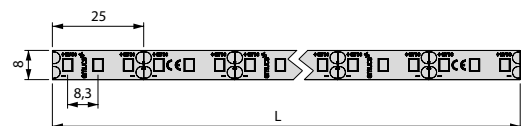

Striscia LED Lynx Basic 9,6W/m IP65 (12V DC)  
LED Streifen Lynx Basic 9,6W/m IP65 (12V DC)



L	Efficienza/Effizienz	Lumen	Potenza/Leistung	Temperatura di colore/Farbtemperatur	LEDs	Finitura/Fertigstellung	Imballaggio/Verpackung	Cod.
5 m	103 lm/W	985 lm/m	9,6 W/m	Bianco freddo 6.000 K/ Kaltweiß 6.000 K	120 LEDs/m	Non classificata/ Nicht bestimmt	2 UN/Einh	5214820
5 m	107 lm/W	1.031 lm/m	9,6 W/m	Bianco caldo 3.000 K/ Warmweiß 3.000 K	120 LEDs/m	Non classificata/ Nicht bestimmt	2 UN/Einh	5214920

Tecnoplastica/Kunststoff

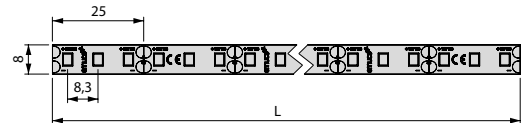
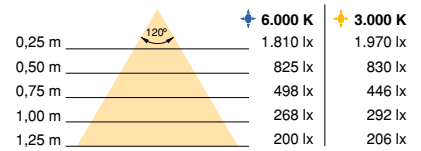

6W	5211020
15W	5211120
30W	5147420
50W	5147520
72W	5008520
100W	5209320
200W	5209420



Un complemento essenziale per l'installazione sono i trasformatore di alimentazione per le luci LED. Devono essere abbastanza piccoli da poter essere nascosti nei mobili.

Eine wichtige Ergänzung für Ihre Installation sind die Transformatoren für Ihre LED-Leuchten. Sie sollten so klein sein, dass sie in den Möbeln versteckt werden können.



Cavo LED Lynx Z (12V DC)

Kabel LED Lynx Z (12V DC)

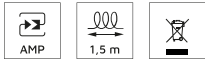

Potenza/Leistung	Input	Output	Finitura/Fertigstellung	Imballaggio/Verpackung	Cod.
60W	12V DC	12V DC	Non classificata/Nicht bestimmt	<input type="checkbox"/>	5207820

Tecnoplastica/Kunststoff

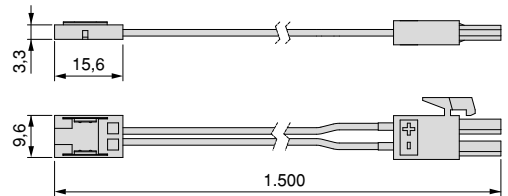

Connettore LED Lynx Z (12V DC) (24V DC)

Verbinder LED Lynx Z (12V DC) (24V DC)



Potenza/Leistung	Input	Output	Finitura/Fertigstellung	Imballaggio/Verpackung	Cod.
48W/96W	12/24V DC	12/24V DC	Non classificata/Nicht bestimmt	<input type="checkbox"/>	5208020

Tecnoplastica/Kunststoff

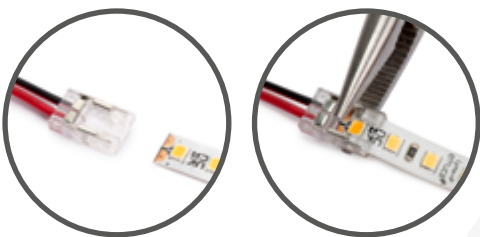
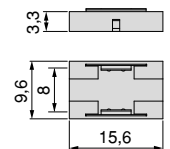
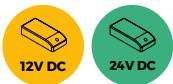

I connettori Lynx Z sono progettati per unire le strisce LED con un giunto solido e resistente, grazie ai loro connettori in metallo. Sono caratterizzati da dimensioni ridotte per unire strisce LED con una larghezza di 8 mm.

Die Lynx Z-Verbinder wurden entwickelt, um LED-Streifen mit einer soliden und widerstandsfähigen Verbindung zu verbinden, dank ihrer Metallverbinder. Sie zeichnen sich durch ihre geringen Abmessungen für die Verbindung von LED-Streifen mit einer Breite von 8 mm aus.

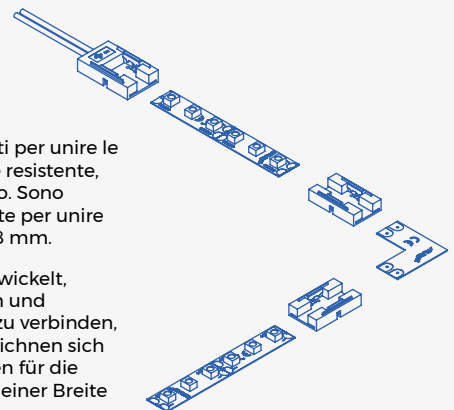

Cavo LED Lynx H (12V DC)

Kabel LED Lynx H (12V DC)

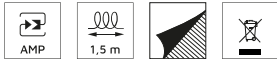

Potenza/Leistung	Input	Output	Finitura/Fertigstellung	Imballaggio/Verpackung	Cod.
60W	12V DC	12V DC	Non classificata/Nicht bestimmt	<input type="checkbox"/> 10 UN/Einh	5061020

Tecnoplastica/Kunststoff

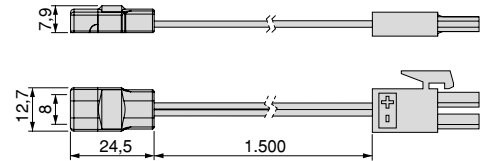

Connettore LED Lynx H (12V DC) (24V DC)

Verbinder LED Lynx H (12V DC) (24V DC)



Potenza/Leistung	Input	Output	Finitura/Fertigstellung	Imballaggio/Verpackung	Cod.
48W/96W	12/24V DC	12/24V DC	Non classificata/Nicht bestimmt	<input type="checkbox"/> 10 UN/Einh	5061120

Tecnoplastica/Kunststoff

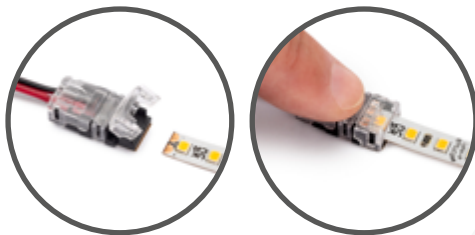
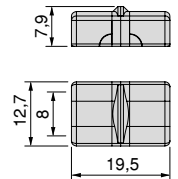

I connettori Lynx H sono progettati per unire le strisce LED con un giunto solido e resistente, ideale per l'uso in combinazione con i profili Lynx. Presentano inoltre una finitura trasparente per ridurre al minimo la riduzione del flusso luminoso.

Die Lynx H-Verbinder wurden entwickelt, um LED-Streifen mit einer soliden und widerstandsfähigen Verbindung zu verbinden, die ideal für die Verwendung mit Lynx-Profilen ist. Sie sind außerdem mit einer transparenten Oberfläche versehen, um die Reduzierung des Lichtstroms zu minimieren.

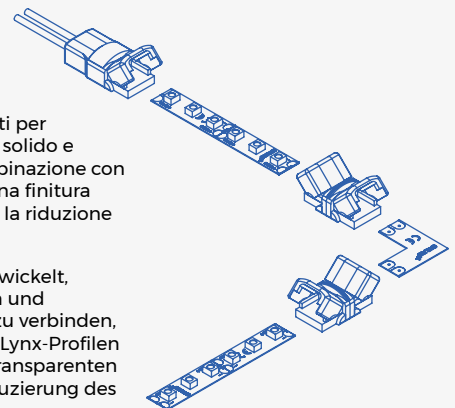



Cavo LED Lynx Q (12V DC)  
Kabel LED Lynx Q (12V DC)

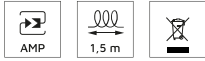

Potenza/Leistung	Input	Output	Finitura/Fertigstellung	Imballaggio/Verpackung	Cod.
36W	12V DC	12V DC	Plastica nera/Schwarzer Kunststoff	10 UN/Einh	7015417

Tecnoplastica/Kunststoff

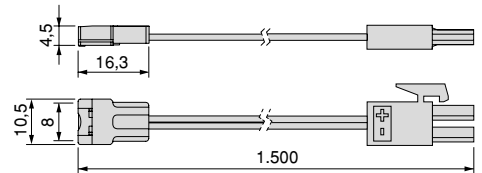

Connettore LED Lynx Q (12V DC)  
Verbinder LED Lynx Q (12V DC)



Potenza/Leistung	Input	Output	Finitura/Fertigstellung	Imballaggio/Verpackung	Cod.
36W/72W	12/24V DC	12/24V DC	Non classificata/Nicht bestimmt	10 UN/Einh	7015520

Tecnoplastica/Kunststoff

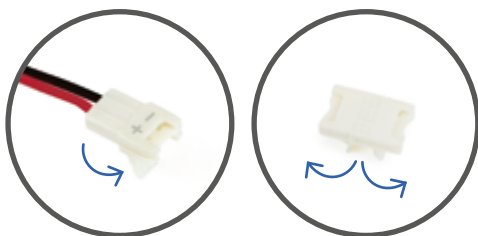
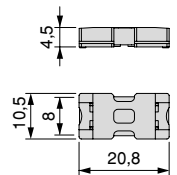
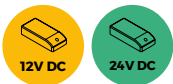

I connettori Lynx Q sono dotati di un coperchio incernierato nella parte inferiore, che fissa la striscia LED, migliorando la connettività e impedendo che si stacchi facilmente, resistendo a forze di trazione fino a 2,5 kg.

Lynx Q Steckverbinder verfügen über eine klappbare Abdeckung an der Unterseite, die den LED-Streifen sichert, die Konnektivität verbessert und verhindert, dass er sich leicht löst, und die Zugkräften von bis zu 2,5 kg standhält.

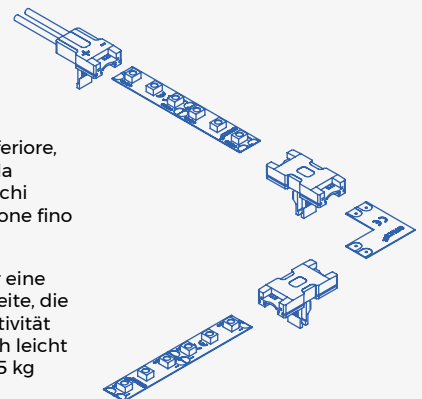

**Connettore LED Lynx Q flessibile (12V DC) (24V DC)**  
**Verbinder LED Lynx Q flexible (12V DC) (24V DC)**



Potenza/Leistung	Input	Output	Finitura/Fertigstellung	Imballaggio/Verpackung	Cod.
36W/72W	12/24V DC	12/24V DC	Non classificata/Nicht bestimmt <input type="checkbox"/>	10 UN/Einh	5203220

Tecnoplastica/Kunststoff

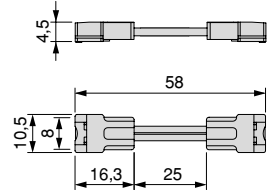
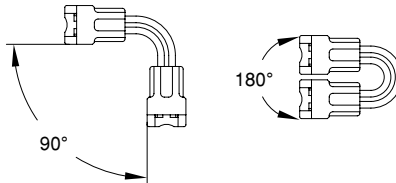
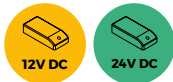

È dotato di un cavo tra i connettori che consente interconnessioni con angoli da 0° a 180° in modo flessibile.

Das Kabel zwischen den Steckern ermöglicht flexible Verbindungen in Winkeln von 0° bis 180°.

**Union L LED Lynx (12V DC) (24V DC)**  
**Lynx Q union LED flexible (12V DC) (24V DC)**



Potenza/Leistung	Input	Output	Finitura/Fertigstellung	Imballaggio/Verpackung	Cod.
48W/96W	12/24V DC	12/24V DC	Non classificata/Nicht bestimmt <input type="checkbox"/>	10 UN/Einh	5202820

Tecnoplastica/Kunststoff

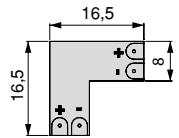
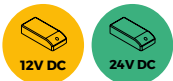

**Prolunga AMP (12V DC)**  
**Verlängerungskabel AMP (12V DC)**



Lunghezza/Längengrad	Potenza/Leistung	Finitura/Fertigstellung	Imballaggio/Verpackung	Cod.
2 m	Max. 60 W	Plastica nera/Schwarzer Kunststoff <input checked="" type="checkbox"/>	25 UN/Einh	9269817

Tecnoplastica/Kunststoff

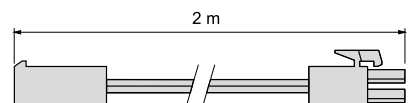

## Strisce LED Lynx Premium 24V DC LED-Streifen Lynx Premium 24V DC

La striscia LED Lynx Premium è adatta per installazioni di lunga durata, poiché ha una buona efficienza e prestazioni elevate.

Lynx Premium LED-Streifen sind für lange Installationen geeignet, da sie eine gute Effizienz und hohe Leistung aufweisen.

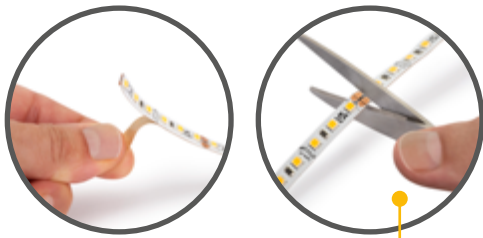

15W 5211220  
30W 5147620  
50W 5147720  
100W 5209520

Il nastro adesivo 3M® 300LSE garantisce la migliore adesione. Das 3M® 300LSE Klebeband bietet die beste Haftung.

### Striscia LED Lynx Premium 9,6 W/m IP20 (24V DC) LED Streifen Lynx Premium 9,6 W/m IP20 (24V DC)

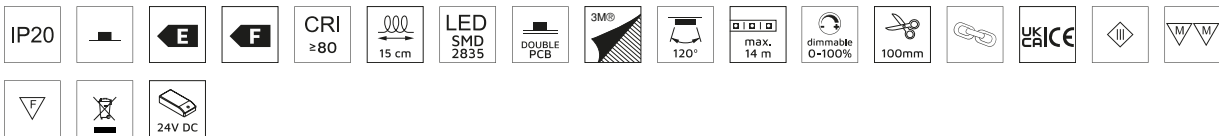

L	Efficienza/Efficienz	Lumen	Potenza/Leistung	Temperatura di colore/Farbtemperatur	LEDs	Finitura/Fertigstellung	Imballaggio/Verpackung	Cod.
10 m	E (1.142 lm / W)	119 lm / m	9,6 W / m	Bianco naturale 4.000 K / Naturweiß 4.000 K	120 LEDs / m	Non classificata / Nicht bestimmt	1 UN/Einh	5205320
10 m	F (1.046 lm / W)	109 lm / m	9,6 W / m	Bianco caldo 2.700 K / Warmweiß 2.700 K	120 LEDs / m	Non classificata / Nicht bestimmt	1 UN/Einh	5205420

Tecnoplastica/Kunststoff



Distance	4.000 K	2.700 K
0,25 m	3.300 lx	3.201 lx
0,50 m	1.325 lx	1.285 lx
0,75 m	655 lx	635 lx
1,00 m	371 lx	360 lx
1,25 m	239 lx	232 lx

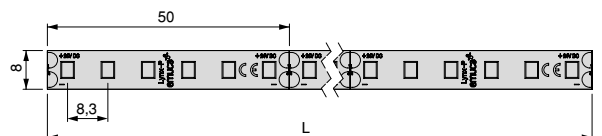

# Strisce LED Lynx Premium COB 24V DC

## LED-Streifen Lynx Premium COB 24V DC

La striscia LED Lynx Premium COB è progettata con una linea continua nota come Chip On Board, che genera una luce LED uniforme e senza punti.

Der Lynx Premium COB-LED-Streifen ist mit einer durchgehenden Linie entworfen, die als Chip On Board bekannt ist und ein gleichmäßiges, punktfreies LED-Licht erzeugt.

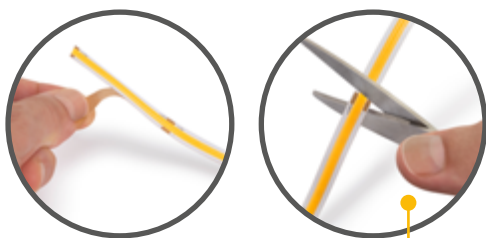

15W 5211220  
30W 5147620  
50W 5147720  
100W 5209520

Si distingue per l'elevata luminanza e la continuità della luce.

Es zeichnet sich durch eine hohe Leuchtdichte und Kontinuität des Lichts aus.

### Lynx Premium COB 9,6 W/m IP20 (24V DC)

#### LED Streifen Lynx Premium COB 9,6 W/m IP20 (24V DC)

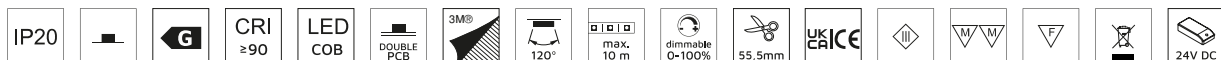

L	Efficienza/Efficienz	Lumen	Potenza/Leistung	Temperatura di colore/Farbtemperatur	LEDs	Finitura/Fertigstellung	Imballaggio/Verpackung	Cod.
5 m	120 lm / W	1.152 lm / m	9,6 W / m	Bianco freddo 6.000 K/ Kaltweiß 6.000 K	480 LEDs / m	Non classificata/ Nicht bestimmt	2 UN/Einh	5216720
5 m	115 lm / W	1.112 lm / m	9,6 W / m	Bianco naturale 4.000 K/ Naturweiß 4.000 K	480 LEDs / m	Non classificata/ Nicht bestimmt	2 UN/Einh	5216820
5 m	105 lm / W	1.015 lm / m	9,6 W / m	Bianco caldo 2.700 K/ Warmweiß 2.700 K	480 LEDs / m	Non classificata/ Nicht bestimmt	2 UN/Einh	5216920

Tecnoplastica/Kunststoff



	6.000 K	4.000 K	2.700 K
0,25 m	1.900 lx	1.800 lx	1.740 lx
0,50 m	810 lx	760 lx	700 lx
0,75 m	450 lx	442 lx	372 lx
1,00 m	294 lx	276 lx	230 lx
1,25 m	214 lx	197 lx	161 lx

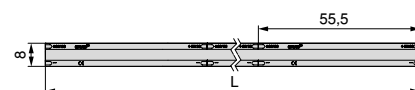

## Strisce LED Neonlynx 24V DC LED-Streifen Neonlynx 24V DC

Le strisce LED Neonlynx sono progettate per creare forme curve per la massima integrazione nell'arredamento.

Die LED-Streifen von Neonlynx sind so konzipiert, dass sie geschwungene Formen bilden und so optimal in die Möbel integriert werden können.

4x11 Neonlynx V 24V DC

12x5 Neonlynx H 24V DC

6x6 Neonlynx H 24V DC

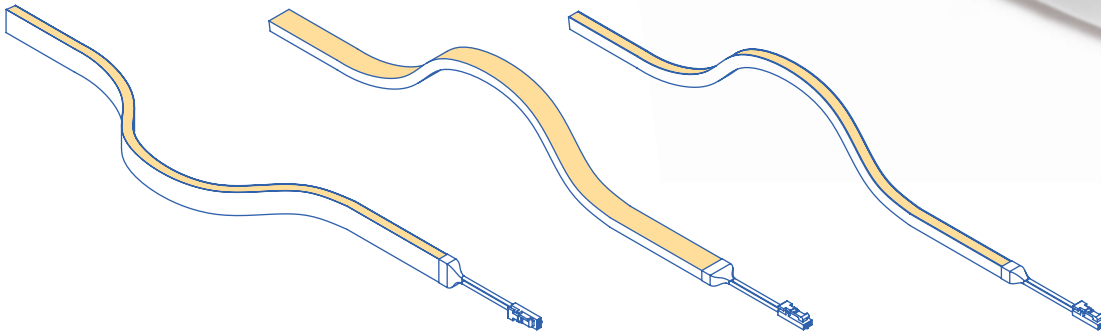

15W	5211220
30W	5147620
50W	5147720
100W	5209520

Sono realizzate in silicone di alta qualità per evitare variazioni di temperatura del colore e hanno un grado di protezione IP65, adatto all'installazione in luoghi umidi.

Sie sind aus hochwertigem Silikon hergestellt, um Farbtemperaturschwankungen zu vermeiden, und haben die Schutzart IP65, die für die Installation in feuchten Räumen geeignet ist.

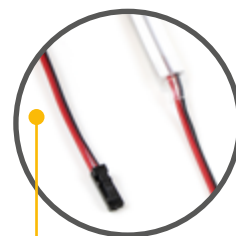

Sono dotate di due cavi di alimentazione da 1,5 m, uno per ogni lato della striscia LED, con connettore miniled.

Sie haben zwei 1,5 m lange Stromkabel, eines auf jeder Seite des LED-Streifens, mit Ministeckern.

# 4x11 Neonlynx V 24V DC

La striscia LED Neonlynx V 4x11 è progettata per forme curve o rettilinee in nicchie di 4 mm di larghezza per 11 mm di profondità, ottenendo la massima integrazione nell'arredamento.

Der LED-Streifen Neonlynx V 4x11 ist für gebogene oder gerade Formen in 4 mm breiten und 11 mm tiefen Aussparungen konzipiert, um eine maximale Integration in die Möbel zu erreichen.

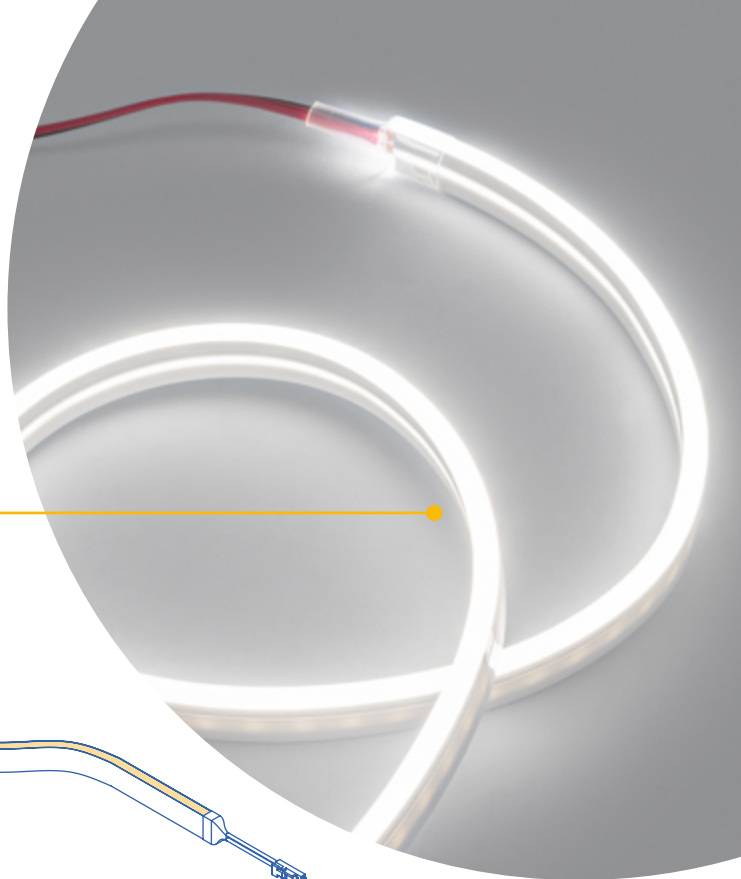

**24V DC**

15W	5211220
30W	5147620
50W	5147720
100W	5209520

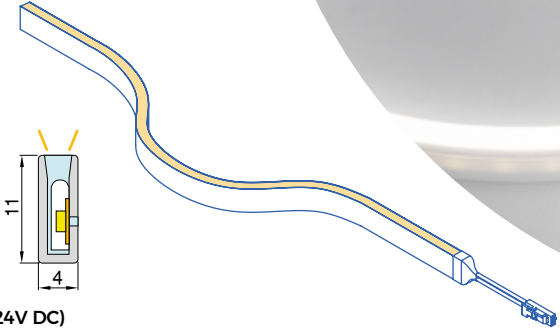

Striscia LED 4x11 Neonlynx V, 7,6W/m IP65 (24V DC)  
LED Streifen 4x11 Neonlynx V, 7,6W/m IP65 (24V DC)

IP65 silicone G D E 1,5 m CRI ≥80 MINILED LED SMD 2835 DOUBLE PCB 160° dimmable 0-100% 63mm UK CR1 CE

W M F 24V DC

L	Efficienza/ Effizienz	Lumen	Potenza/Leis- tung	Temperatura di colore/ Farbtemperatur	LEDs	Finitura/Fertigstellung	Imballaggio/ Verpackung	Cod.
1.008 mm	G (42 lm / W)	316 lm / m	7,6 W / m	Bianco freddo 6.000 K/ Kaltweiß 6.000 K	128 LEDs / m	Non classificata/ Nicht bestimmt	8 UN/Einh	5206320
3.024 mm	G (42 lm / W)	316 lm / m	7,6 W / m	Bianco freddo 6.000 K/ Kaltweiß 6.000 K	128 LEDs / m	Non classificata/ Nicht bestimmt	2 UN/Einh	5206420
5.040 mm	G (42 lm / W)	316 lm / m	7,6 W / m	Bianco freddo 6.000 K/ Kaltweiß 6.000 K	128 LEDs / m	Non classificata/ Nicht bestimmt	2 UN/Einh	5206520
1.008 mm	D (49 lm / W)	375 lm / m	7,6 W / m	Bianco naturale 4.000 K/ Naturweiß 4.000 K	128 LEDs / m	Non classificata/ Nicht bestimmt	8 UN/Einh	5204220
3.024 mm	D (49 lm / W)	375 lm / m	7,6 W / m	Bianco naturale 4.000 K/ Naturweiß 4.000 K	128 LEDs / m	Non classificata/ Nicht bestimmt	2 UN/Einh	5204320
5.040 mm	D (49 lm / W)	375 lm / m	7,6 W / m	Bianco naturale 4.000 K/ Naturweiß 4.000 K	128 LEDs / m	Non classificata/ Nicht bestimmt	2 UN/Einh	5204420
1.008 mm	E (49 lm / W)	370 lm / m	7,6 W / m	Bianco caldo 2.700 K/ Warmweiß 2.700 K	128 LEDs / m	Non classificata/ Nicht bestimmt	8 UN/Einh	5206020
3.024 mm	E (49 lm / W)	370 lm / m	7,6 W / m	Bianco caldo 2.700 K/ Warmweiß 2.700 K	128 LEDs / m	Non classificata/ Nicht bestimmt	2 UN/Einh	5206120
5.040 mm	E (49 lm / W)	370 lm / m	7,6 W / m	Bianco caldo 2.700 K/ Warmweiß 2.700 K	128 LEDs / m	Non classificata/ Nicht bestimmt	2 UN/Einh	5206220

Tecnoplastica/Kunststoff

**24V DC** **7,6W/m** **IP65**

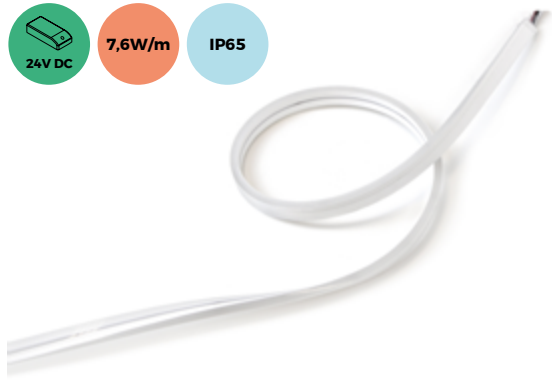

	6.000 K	4.000 K	2.700 K
0,25 m	1.011 lx	1.075 lx	1.043 lx
0,50 m	439 lx	467 lx	453 lx
0,75 m	247 lx	263 lx	255 lx
1,00 m	151 lx	160 lx	155 lx
1,25 m	100 lx	106 lx	103 lx

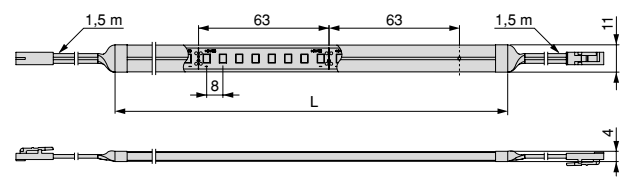

# 12x5 Neonlynx H 24V DC

La striscia LED Neonlynx H 12x5 ha un'altezza ridotta con un'illuminazione superiore, che ne consente l'utilizzo sulla superficie del mobile e la piegatura per realizzare le curve.

Die LED-Leiste 12x5 Neonlynx H hat eine geringere Höhe und eine bessere Ausleuchtung, so dass sie auf der Oberfläche des Möbels verwendet und für Kurven gebogen werden kann.

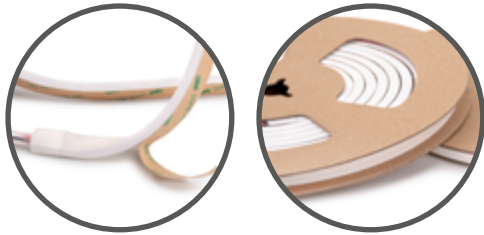

**24V DC**

15W	5211220
30W	5147620
50W	5147720
100W	5209520

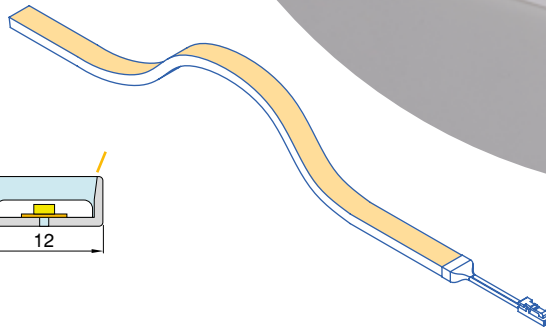
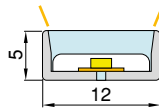

## Striscia LED 12x5 Neonlynx H, 7,6W/m IP65 (24V DC) LED Streifen 12x5 Neonlynx H, 7,6W/m IP65 (24V DC)

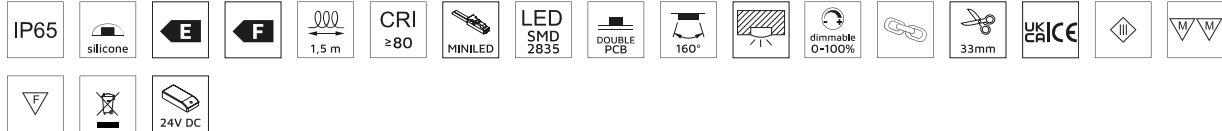

L	Efficienza/ Effizienz	Lumen	Potenza/ Leistung	Temperatura di colore/ Farbtemperatur	LEDs	Finitura/Fertigstellung	Imballaggio/ Verpackung	Cod.
1.000 mm	E (129 lm / W)	983 lm / m	7,6 W / m	Bianco naturale 4.000 K/ Naturweiß 4.000 K	240 LEDs / m	Non classificata/ Nicht bestimmt	8 UN/Einh	5217720
3.000 mm	E (129 lm / W)	983 lm / m	7,6 W / m	Bianco naturale 4.000 K/ Naturweiß 4.000 K	240 LEDs / m	Non classificata/ Nicht bestimmt	2 UN/Einh	5217820
5.000 mm	E (129 lm / W)	983 lm / m	7,6 W / m	Bianco naturale 4.000 K/ Naturweiß 4.000 K	240 LEDs / m	Non classificata/ Nicht bestimmt	2 UN/Einh	5217920
1.000 mm	F (125 lm / W)	953 lm / m	7,6 W / m	Bianco caldo 2.700 K/ Warmweiß 2.700 K	240 LEDs / m	Non classificata/ Nicht bestimmt	8 UN/Einh	5219420
3.000 mm	F (125 lm / W)	953 lm / m	7,6 W / m	Bianco caldo 2.700 K/ Warmweiß 2.700 K	240 LEDs / m	Non classificata/ Nicht bestimmt	2 UN/Einh	5219520
5.000 mm	F (125 lm / W)	953 lm / m	7,6 W / m	Bianco caldo 2.700 K/ Warmweiß 2.700 K	240 LEDs / m	Non classificata/ Nicht bestimmt	2 UN/Einh	5219620

Tecnoplastica/Kunststoff

**24V DC** **7,6W/m** **IP65**

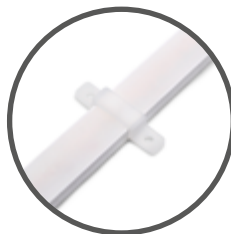

Length	4.000 K	2.700 K
0,25 m	2.820 lx	2.735 lx
0,50 m	1.280 lx	1.242 lx
0,75 m	770 lx	747 lx
1,00 m	494 lx	479 lx
1,25 m	346 lx	336 lx

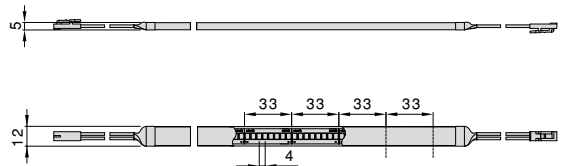

# 6x6 Neonlynx H 24V DC

La striscia LED Neonlynx H 6x6 è progettata per forme curve o rettilinee in nicchie di 6 mm di larghezza per 6 mm di profondità, ottenendo la massima integrazione nel mobile.

Die LED-Leiste 6x6 Neonlynx H ist für gebogene oder gerade Formen in Aussparungen von 6 mm Breite und 6 mm Tiefe konzipiert, um eine maximale Integration in das Möbelstück zu erreichen.

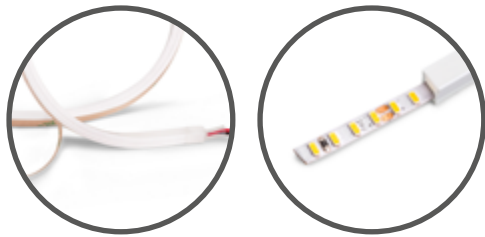

**24V DC**

15W	5211220
30W	5147620
50W	5147720
100W	5209520

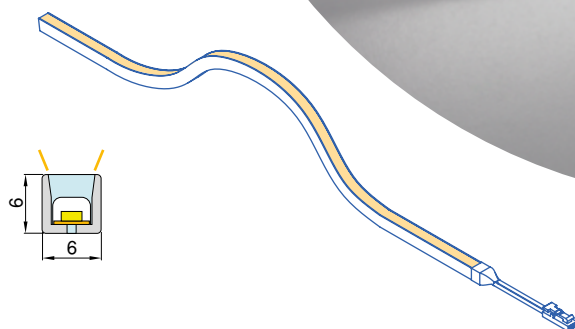

## Striscia LED 6x6 Neonlynx H, 7,6W/m IP65 (24V DC) LED Streifen 6x6 Neonlynx H, 7,6W/m IP65 (24V DC)

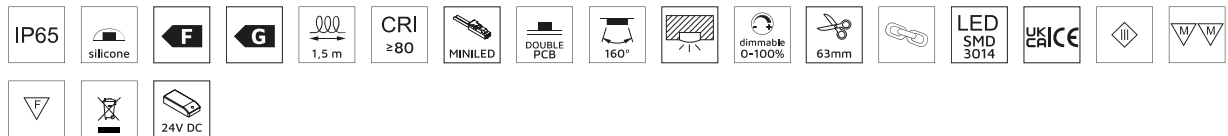

L	Efficienza/ Effizienz	Lumen	Potenza/Leis- tung	Temperatura di colore/ Farbtemperatur	LEDs	Finitura/Fertigstellung	Imballaggio/ Verpackung	Cod.
1.008 mm	G (87 lm / W)	632 lm / m	7,2 W / m	Bianco naturale 4.000 K/ Naturweiß 4.000 K	210 LEDs / m	Non classificata/ Nicht bestimmt	8 UN/Einh	5219720
3.024 mm	G (87 lm / W)	632 lm / m	7,2 W / m	Bianco naturale 4.000 K/ Naturweiß 4.000 K	210 LEDs / m	Non classificata/ Nicht bestimmt	2 UN/Einh	5219820
5.040 mm	G (87 lm / W)	632 lm / m	7,2 W / m	Bianco naturale 4.000 K/ Naturweiß 4.000 K	210 LEDs / m	Non classificata/ Nicht bestimmt	2 UN/Einh	5219920
1.008 mm	F (90 lm / W)	652 lm / m	7,2 W / m	Bianco caldo 2.700 K/ Warmweiß 2.700 K	240 LEDs / m	Non classificata/ Nicht bestimmt	8 UN/Einh	5220120
3.024 mm	F (90 lm / W)	652 lm / m	7,2 W / m	Bianco caldo 2.700 K/ Warmweiß 2.700 K	210 LEDs / m	Non classificata/ Nicht bestimmt	2 UN/Einh	5220220
5.040 mm	F (90 lm / W)	652 lm / m	7,2 W / m	Bianco caldo 2.700 K/ Warmweiß 2.700 K	210 LEDs / m	Non classificata/ Nicht bestimmt	2 UN/Einh	5220320

Tecnoplastica/Kunststoff

**24V DC** **7,6W/m** **IP65**

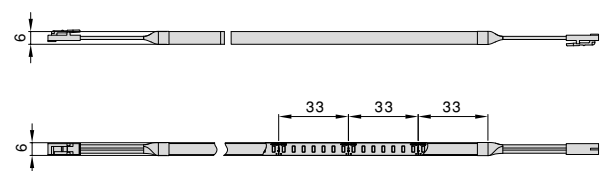
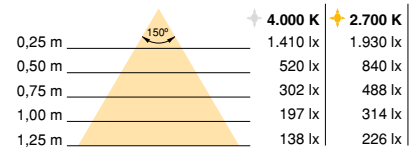
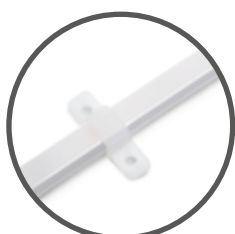



Cavo LED Lynx Z (24V DC)

Kabel LED Lynx Z (24V DC)



Potenza/Leistung	Input	Output	Finitura/Fertigstellung	Imballaggio/Verpackung	Cod.
72W	24V DC	24V DC	Non classificata/Nicht bestimmt	<input type="checkbox"/> 10 UN/Einh	5207920

Tecnoplastica/Kunststoff

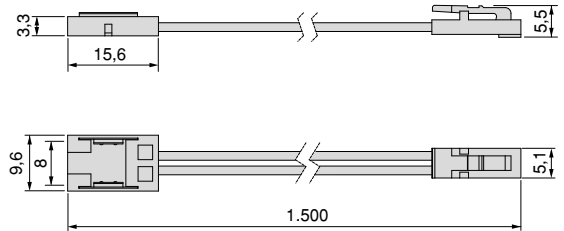

Connettore LED Lynx Z (12V DC) (24V DC)

Verbinder LED Lynx Z (12V DC) (24V DC)



Potenza/Leistung	Input	Output	Finitura/Fertigstellung	Imballaggio/Verpackung	Cod.
48W/96W	12/24V DC	12/24V DC	Non classificata/Nicht bestimmt	<input type="checkbox"/> 10 UN/Einh	5208020

Tecnoplastica/Kunststoff

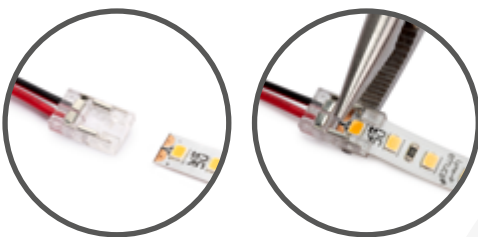
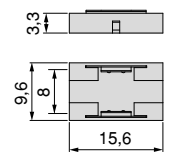
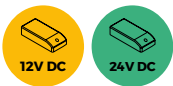

I connettori Lynx Z sono progettati per unire le strisce LED con un giunto solido e resistente, grazie ai loro connettori in metallo. Sono caratterizzati da dimensioni ridotte per unire strisce LED con una larghezza di 8 mm.

Die Lynx Z-Verbinder wurden entwickelt, um LED-Streifen mit einer soliden und widerstandsfähigen Verbindung zu verbinden, dank ihrer Metallverbinder. Sie zeichnen sich durch ihre geringen Abmessungen für die Verbindung von LED-Streifen mit einer Breite von 8 mm aus.

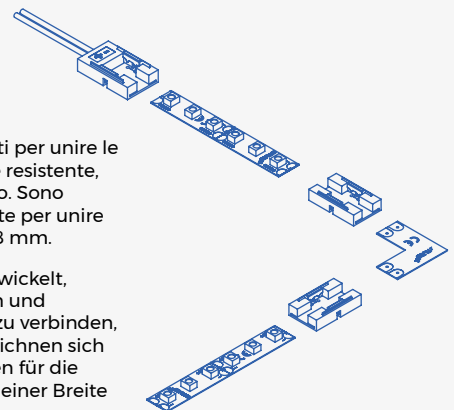

Cavo LED Lynx H (24V DC)

Kabel LED Lynx H (24V DC)



Potenza/Leistung	Input	Output	Finitura/Fertigstellung	Imballaggio/Verpackung	Cod.
72W	24V DC	24V DC	Non classificata/Nicht bestimmt <input type="checkbox"/>	10 UN/Einh	5204820

Tecnoplastica/Kunststoff

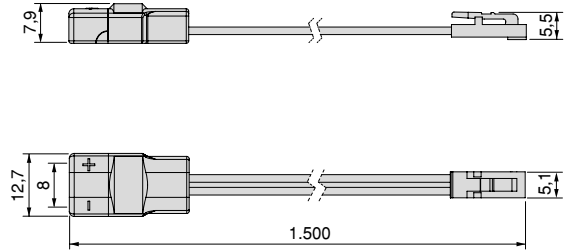

Connettore LED Lynx H (12V DC) (24V DC)

Verbinder LED Lynx H (12V DC) (24V DC)



Potenza/Leistung	Input	Output	Finitura/Fertigstellung	Imballaggio/Verpackung	Cod.
48W/96W	12/24V DC	12/24V DC	Non classificata/Nicht bestimmt <input type="checkbox"/>	10 UN/Einh	5061120

Tecnoplastica/Kunststoff

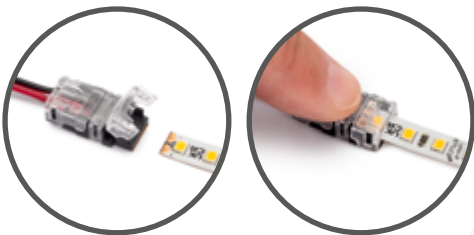
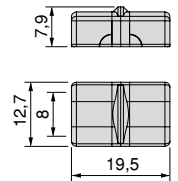
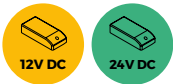

I connettori Lynx H sono progettati per unire le strisce LED con una giunzione solida e resistente, ideale per l'uso in combinazione con i profili Lynx. Presentano inoltre una finitura trasparente per ridurre al minimo la riduzione del flusso luminoso.

Die Lynx H-Verbinder wurden entwickelt, um LED-Streifen mit einer soliden und starken Verbindung zu verbinden. Sie sind ideal für die Verwendung in Verbindung mit Lynx-Profilen. Sie sind außerdem mit einer transparenten Oberfläche versehen, um die Reduzierung des Lichtstroms zu minimieren.

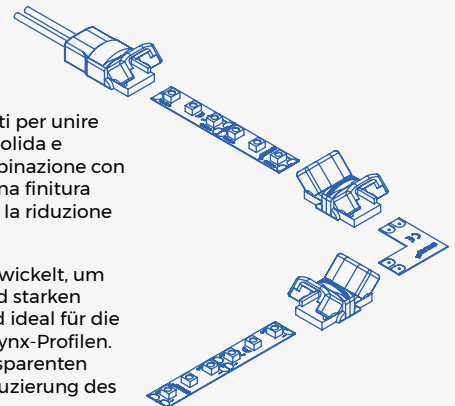

Cavo LED Lynx Q (24V DC)

Cavo LED Lynx Q (24V DC)



Potenza/Leistung	Input	Output	Finitura/Fertigstellung	Imballaggio/Verpackung	Cod.
72W	24V DC	24V DC	Non classificata/Nicht bestimmt	<input type="checkbox"/>	10 UN/Einh 5221820

Tecnoplastica/Kunststoff

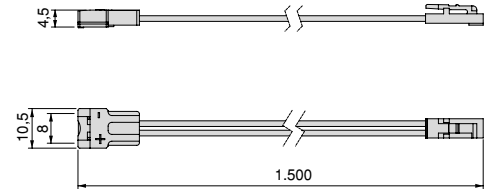

Connettore LED Lynx Q (12V DC)

Verbinder LED Lynx Q (12V DC)



Potenza/Leistung	Input	Output	Finitura/Fertigstellung	Imballaggio/Verpackung	Cod.
36W/72W	12/24V DC	12/24V DC	Non classificata/Nicht bestimmt	<input type="checkbox"/>	10 UN/Einh 7015520

Tecnoplastica/Kunststoff

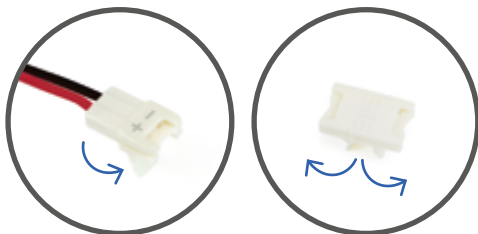
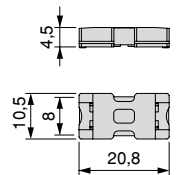
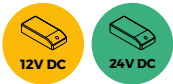

I connettori Lynx Q sono dotati di un coperchio incernierato nella parte inferiore, che fissa la striscia LED, migliorando la connettività e impedendo che si stacchi facilmente, resistendo a forze di trazione fino a 2,5 kg.

Die Lynx Q Steckverbinder verfügen über eine klappbare Abdeckung an der Unterseite, die den LED-Streifen fixiert, die Konnektivität verbessert und verhindert, dass er sich leicht löst, wobei er Zugkräften von bis zu 2,5 kg standhält.

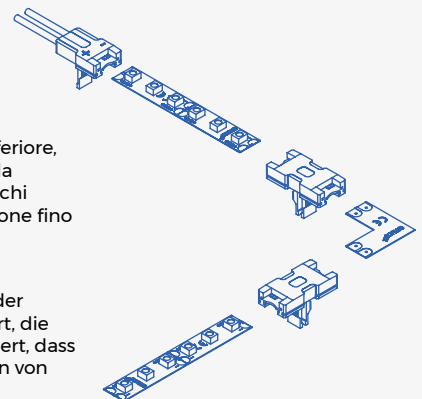

**Connettore LED Lynx Q flessibile (12V DC) (24V DC)**  
**Verbinder LED Lynx Q flexible (12V DC) (24V DC)**



Potenza/Leistung	Input	Output	Finitura/Fertigstellung	Imballaggio/Verpackung	Cod.
36W/72W	12/24V DC	12/24V DC	Non classificata/Nicht bestimmt <input type="checkbox"/>	10 UN/Einh	5203220

Tecnoplastica/Kunststoff

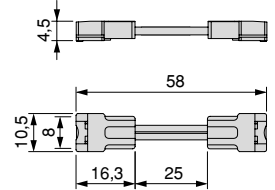
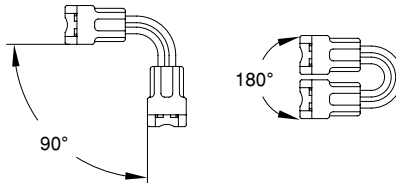
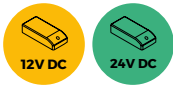

È dotato di un cavo tra i connettori che consente interconnessioni con angoli da 0° a 180° in modo flessibile.

Das Kabel zwischen den Steckverbindern ermöglicht flexible Verbindungen in Winkeln von 0° bis 180°.

**Union L LED Lynx (12V DC) (24V DC)**  
**Lynx Q union LED flexible (12V DC) (24V DC)**



Potenza/Leistung	Input	Output	Finitura/Fertigstellung	Imballaggio/Verpackung	Cod.
48W/96W	12/24V DC	12/24V DC	Non classificata/Nicht bestimmt <input type="checkbox"/>	10 UN/Einh	5202820

Tecnoplastica/Kunststoff

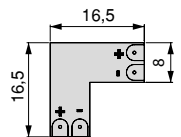
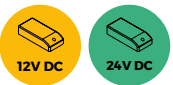

**Cavo prolunga Miniled (24V DC)**  
**Verlängerungskabel MiniLED (24V DC)**

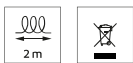

Potenza/Leistung	Input	Output	Finitura/Fertigstellung	Imballaggio/Verpackung	Cod.
72W	24V DC	24V DC	Non classificata/Nicht bestimmt <input type="checkbox"/>	25 UN/Einh	5204920

Tecnoplastica/Kunststoff



Può essere utilizzato per estendere 2 metri se la distanza tra il convertitore e l'apparecchio di illuminazione è molto grande.

Es kann verwendet werden, um 2 Meter zu verlängern, wenn der Abstand zwischen dem Konverter und der Leuchte sehr groß ist.

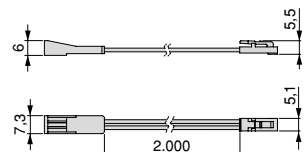

## Sensori Lynx Lynx Sensoren

I sensori Lynx Z aggiungono funzionalità alle installazioni di strisce LED come interruttore o rilevatore.

Lynx Z Sensoren erweitern Ihre LED-Streifen-Installationen um die Funktionalität eines Schalters oder Detektors.

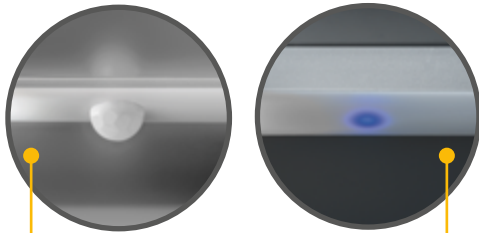

Il sensore accende l'apparecchio quando l'utente interferisce con il suo campo di rilevamento e si spegne dopo 30 secondi.

Der Sensor schaltet die Leuchte ein, wenn der Benutzer in seinen Erfassungsbereich eingreift, und schaltet sich nach 30 Sekunden aus.



Il sensore accende o spegne l'apparecchio con una pressione breve e aumenta o diminuisce il flusso luminoso con una pressione prolungata.

Mit einem kurzen Druck schaltet der Sensor die Leuchte ein oder aus, mit einem langen Druck erhöht oder verringert er den Lichtstrom.

Sono dotati di un connettore integrato per un collegamento rapido, facile e sicuro.

Sie haben einen eingebauten Stecker für einen schnellen, einfachen und sicheren Anschluss.



Sono caratterizzati da dimensioni ridotte per il collegamento di strisce LED di 8 mm di larghezza, ideali per l'uso in combinazione con i profili Lynx W.

Sie zeichnen sich durch ihre geringen Abmessungen für den Anschluss von 8 mm breiten LED-Streifen aus, ideal für den Einsatz in Verbindung mit Lynx W-Profilen.

Sensori per strisce LED Lynx Z Motion (12V DC) (24V DC)

Sensor für LED Streifen Lynx Z Motion (12V DC) (24V DC)

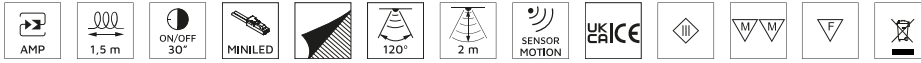

Modello/Modell	Potenza/Leistung	Input	Output	Finitura/Fertigstellung	Imballaggio/Verpackung	Cod.
MOTION	36W/72W	12/24V DC	12/24V DC	Non classificata/Nicht bestimmt	10 UN/Einh	5208220

Tecnoplastica/Kunststoff

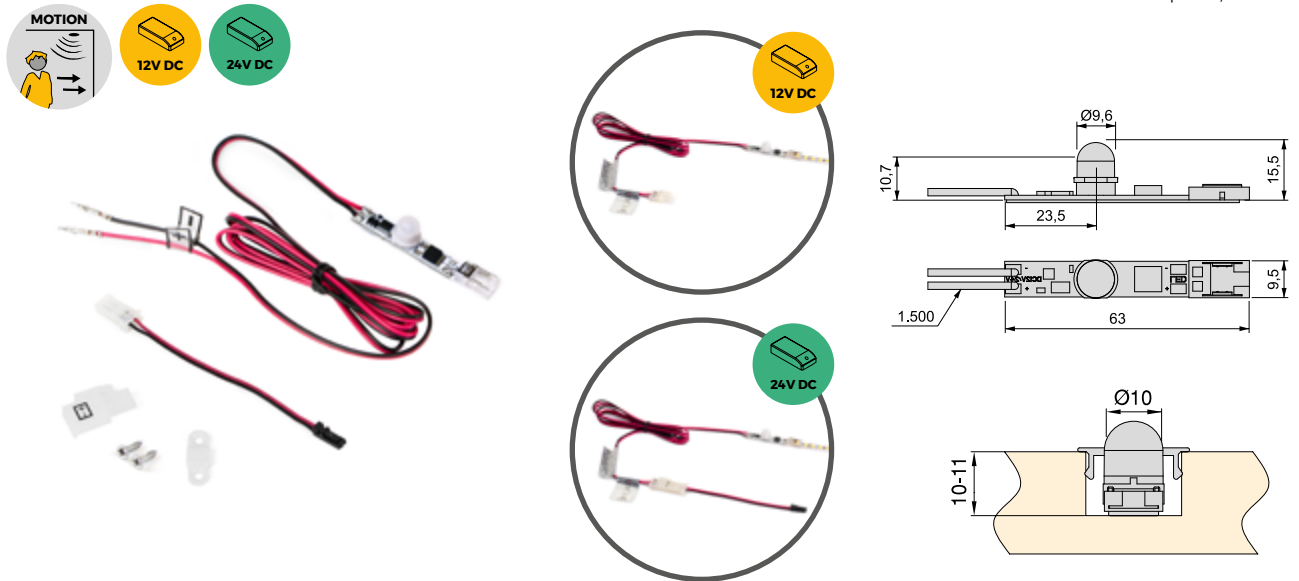

Sensori per strisce LED Lynx Z Touch Dimmer (12V DC) (24V DC)

Sensor für LED Streifen Lynx Z Touch Dimmer (12V DC) (24V DC)



Modello/Modell	Potenza/Leistung	Input	Output	Finitura/Fertigstellung	Imballaggio/Verpackung	Cod.
TOUCH / DIMMER	36W/72W	12/24V DC	12/24V DC	Non classificata/Nicht bestimmt	10 UN/Einh	5208120

Tecnoplastica/Kunststoff

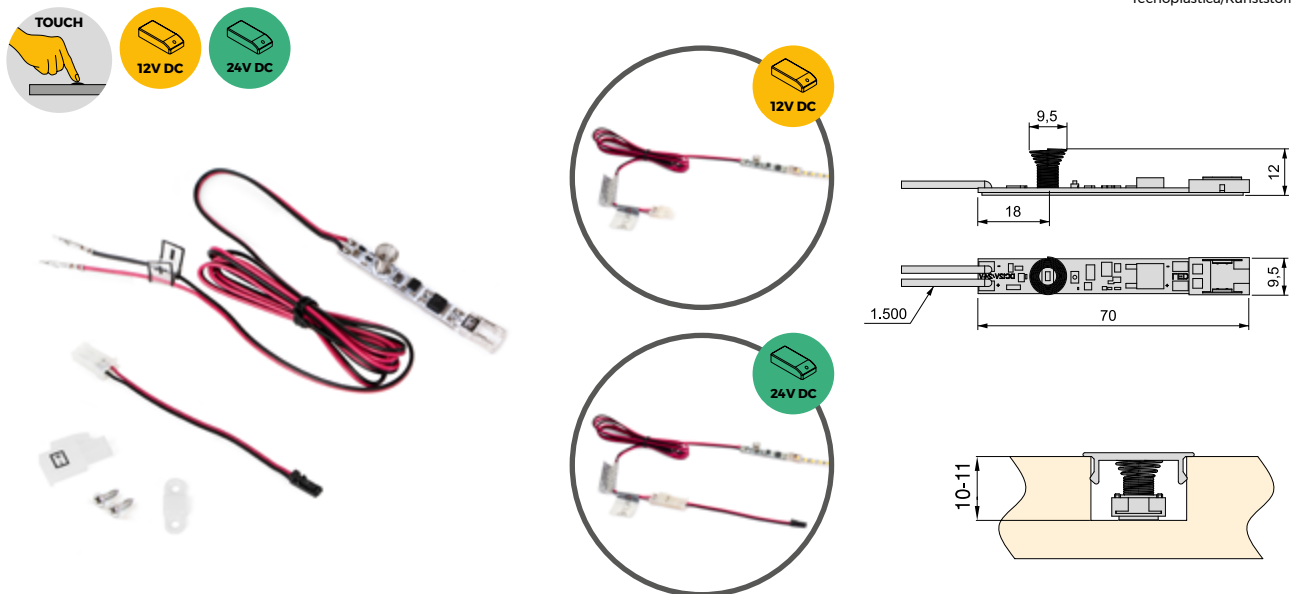

## Profili Lynx Lynx Profile

I profili Lynx sono progettati per creare apparecchi di illuminazione integrati nei mobili con le strisce LED Lynx. Rappresentano la soluzione migliore per installare facilmente l'illuminazione con i profili in alluminio.

Lynx-Profile wurden entwickelt, um mit Lynx-LED-Leisten in die Möbel integrierte Leuchten zu schaffen. Sie sind die beste Lösung für einfache Beleuchtungsinstallationen mit Aluminiumprofilen.



### PROFILI LYNX W / LYNX W-PROFILE W

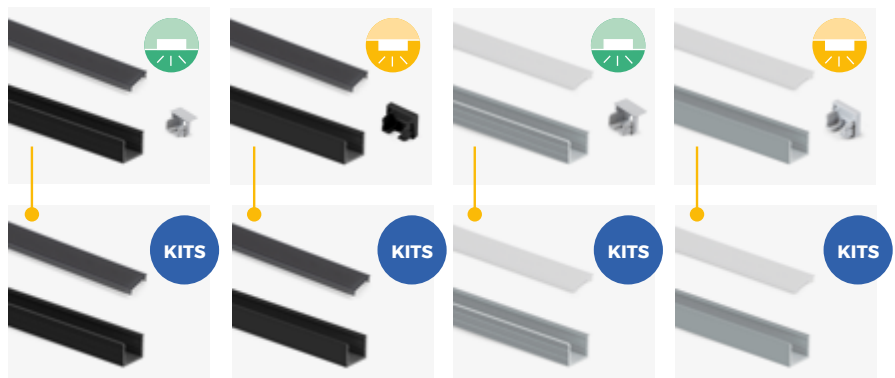

### PROFILI LYNX W / LYNX W-PROFILE

#### PIATTO / FLACH

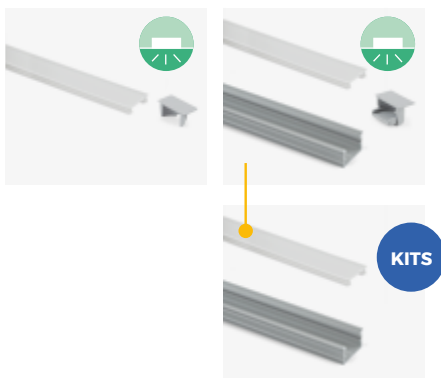

#### CURVO / ROUND

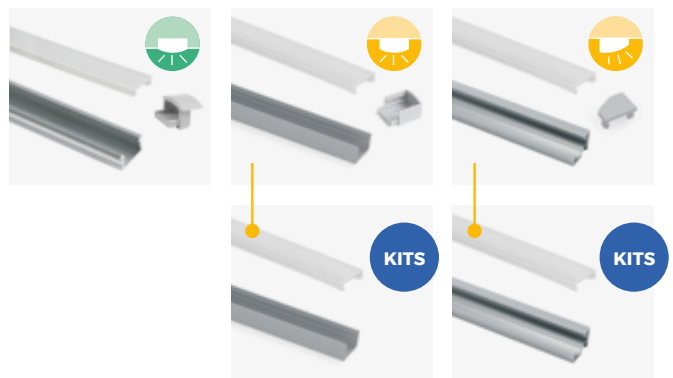

**Profilo diffusore Lynx W per strisce LED**  
**Diffusorprofil Lynx W für LED Streifen**



Lunghezza/Längengrad	Finitura/Fertigstellung	Imballaggio/Verpackung	Cod.
2,35 m	Plastica bianca/Weißer Kunststoff	20 UN/Einh	5147815
2,35 m	Plastica nera/Schwarzer Kunststoff	20 UN/Einh	5147817

Tecnoplastica/Kunststoff

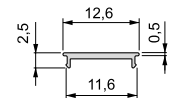
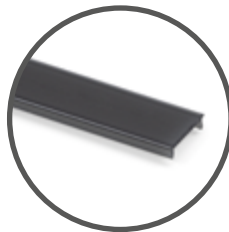

**Profilo Lynx W da incasso per strisce LED**  
**Lynx W Profil für LED-Einbauleuchten**



Lunghezza/Längengrad	Finitura/Fertigstellung	Imballaggio/Verpackung	Cod.
2,35 m	Anodizzato opaco/Matt eloxiert	20 UN/Einh	5147962
2,35 m	Anodizzato nero/Schwarz eloxiert	20 UN/Einh	5147967

Alluminio/Aluminium

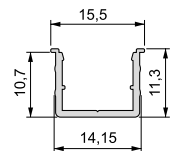
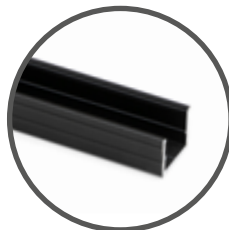
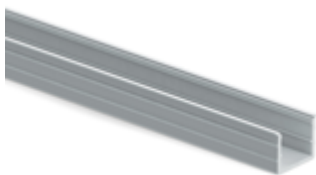

**Accessorio per incasso in profilo di alluminio Lynx W**  
**Zubehör für Unterbauprofil Lynx W**



Finitura/Fertigstellung	Imballaggio/Verpackung	Cod.
Plastica grigia/Grau	20 UN/Einh	5148421
Plastica nera/Schwarzer Kunststoff	20 UN/Einh	5148417

Tecnoplastica/Kunststoff

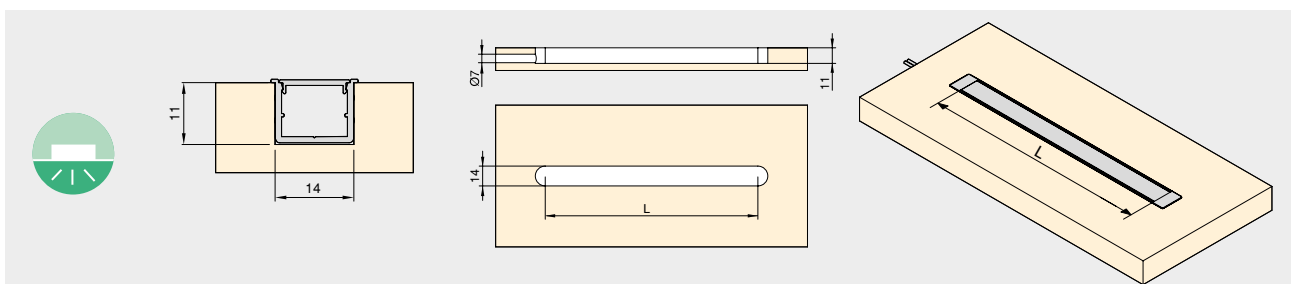
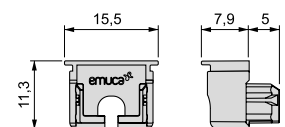



Profilo diffusore Lynx W per strisce LED  
 Diffusorprofil Lynx W für LED Streifen



Lunghezza/Längengrad	Finitura/Fertigstellung	Imballaggio/Verpackung	Cod.
2,35 m	Plastica bianca/Weißer Kunststoff	20 UN/Einh	5147815
2,35 m	Plastica nera/Schwarzer Kunststoff	20 UN/Einh	5147817

Tecnoplastica/Kunststoff

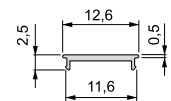
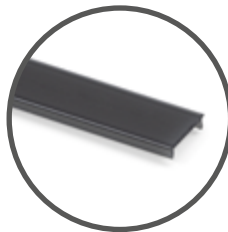

Profilo Lynx W per montaggio a superficie  
 Lynx W Unterbauprofil für LED Streifen



Lunghezza/Längengrad	Finitura/Fertigstellung	Imballaggio/Verpackung	Cod.
2,35 m	Anodizzato opaco/Matt eloxiert	20 UN/Einh	5148062
2,35 m	Anodizzato nero/Schwarz eloxiert	20 UN/Einh	5148067

Alluminio/Aluminium

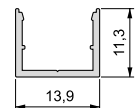
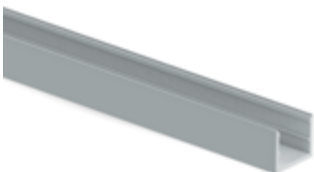

Accessori per montaggio a superficie Lynx W  
 Abdeckkappen für LED-Lynx W Streifen



Finitura/Fertigstellung	Imballaggio/Verpackung	Cod.
Plastica grigia/Grau	10 UN/Einh	5148521
Plastica nera/Schwarzer Kunststoff	10 UN/Einh	5148517

Tecnoplastica/Kunststoff

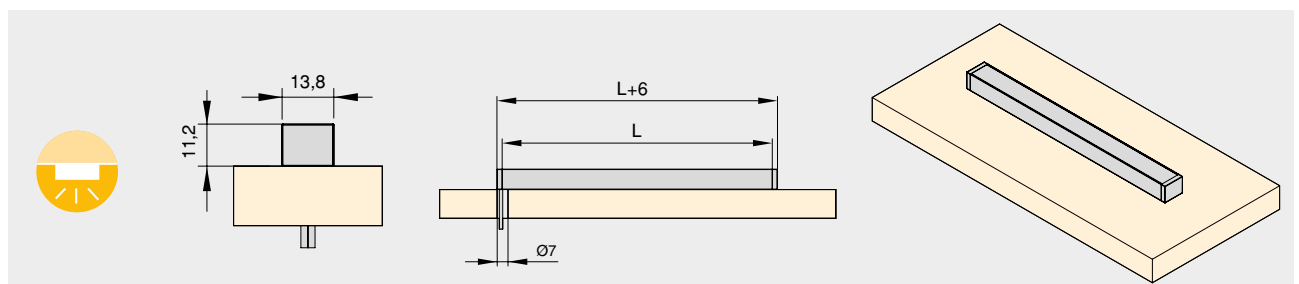
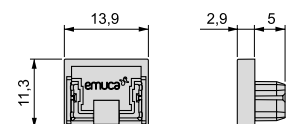
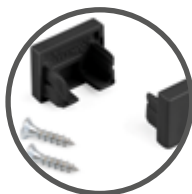

Profili Lynx W da incasso per strisce LED  
 Lynx W Profile für LED-Einbauleuchten



Lunghezza/Längengrad	Finitura/Fertigstellung	Imballaggio/Verpackung	Cod.
2,35 m	Anodizzato opaco/Matt eloxiert	8 UN/Einh	5148962
2,35 m	Anodizzato nero/Schwarz eloxiert	8 UN/Einh	5148967

Alluminio/Aluminium

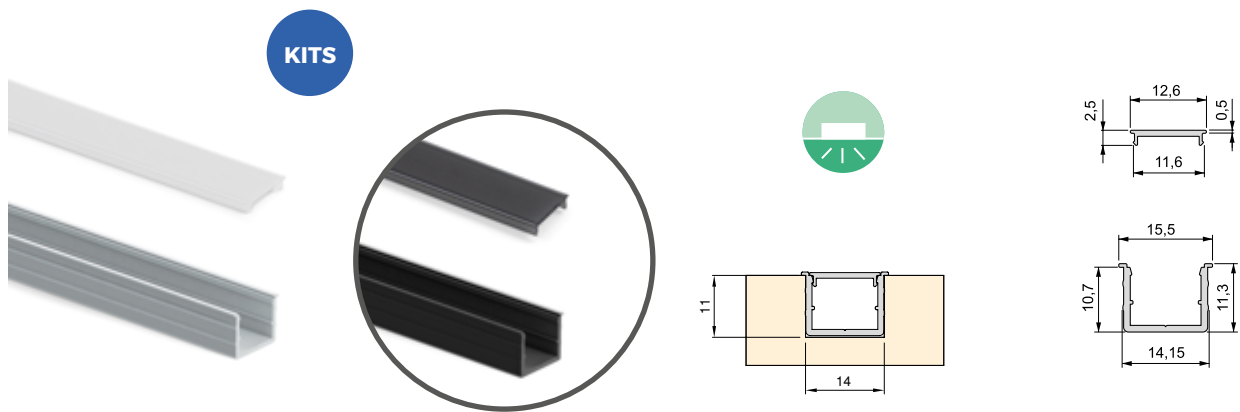

Profili Lynx W per montaggio a superficie per strisce LED  
 Lynx W Unterbauprofile für LED Streifen



Lunghezza/Längengrad	Finitura/Fertigstellung	Imballaggio/Verpackung	Cod.
2,35 m	Anodizzato opaco/Matt eloxiert	8 UN/Einh	5149062
2,35 m	Anodizzato nero/Schwarz eloxiert	8 UN/Einh	5149067

Alluminio/Aluminium

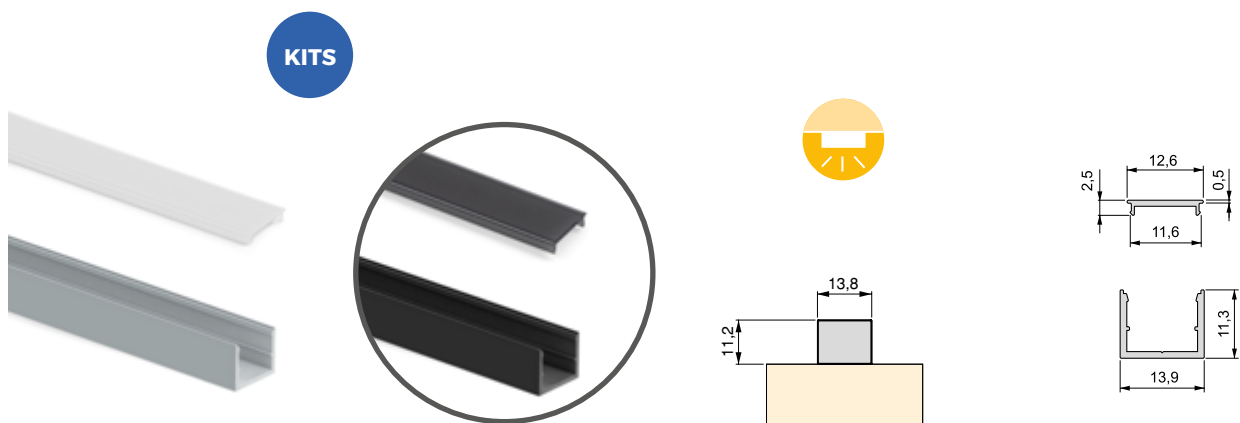

Profilo diffusore piatto per strisce LED  
 Diffusorprofil flach für LED Streifen



Lunghezza/Längengrad	Finitura/Fertigstellung	Imballaggio/Verpackung	Cod.
2,35 m	Plastica bianca/Weißer Kunststoff	20 UN/Einh	5147115
3,9 m	Plastica bianca/Weißer Kunststoff	20 UN/Einh	5146415

Tecnoplastica/Kunststoff

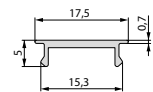

Accessori per incasso in legno del diffusore piano  
 Zubehör für Einbau in Holz das flache Diffusorprofil



Finitura/Fertigstellung	Imballaggio/Verpackung	Cod.
Plastica grigia/Grau	10 UN/Einh	5146821

Tecnoplastica/Kunststoff

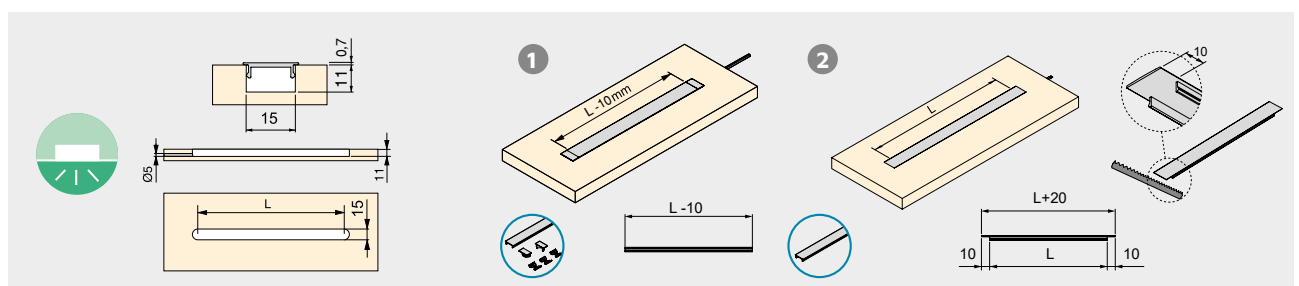
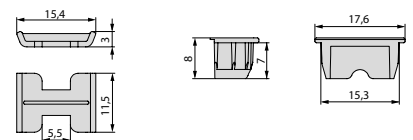

**Profilo diffusore piatto per strisce LED**  
**Diffusorprofil flach für LED Streifen**



Lunghezza/Längengrad	Finitura/Fertigstellung	Imballaggio/Verpackung	Cod.
2,35 m	Plastica bianca/Weißer Kunststoff	20 UN/Einh	5147115
3,9 m	Plastica bianca/Weißer Kunststoff	20 UN/Einh	5146415

Tecnoplastica/Kunststoff

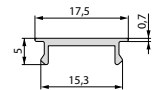

**Profilo piatto da incasso per strisce LED**  
**Flaches Profil zum Einbauen für LED Streifen**



Lunghezza/Längengrad	Finitura/Fertigstellung	Imballaggio/Verpackung	Cod.
2,35 m	Anodizzato opaco/Matt eloxiert	20 UN/Einh	5085262
3,9 m	Anodizzato opaco/Matt eloxiert	20 UN/Einh	5146762

Alluminio/Aluminium

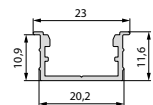
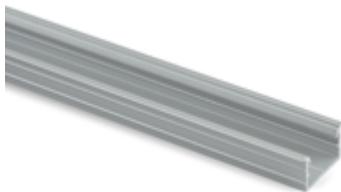

**Accessorio per incasso in profilo di alluminio del diffusore piano**  
**Zubehör für Einbau in Aluminiumprofil das flache Diffusorprofil**



Finitura/Fertigstellung	Imballaggio/Verpackung	Cod.
Plastica grigia/Grau	20 UN/Einh	5146921

Tecnoplastica/Kunststoff

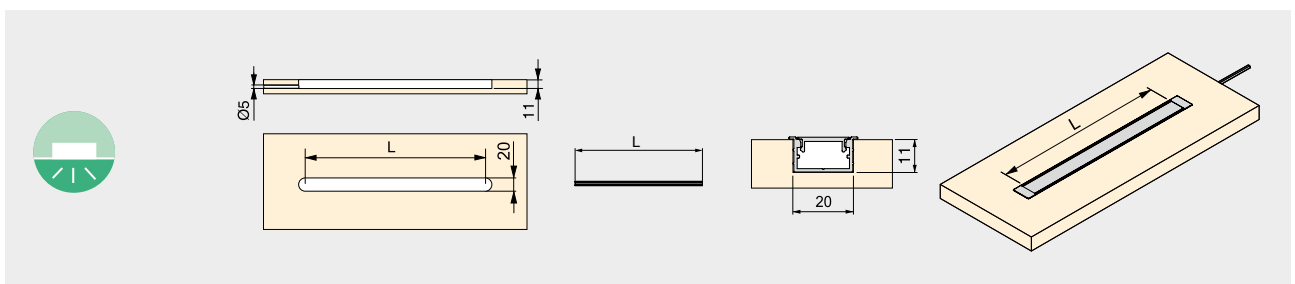
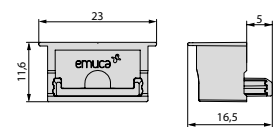

**Profilo diffusore curvo per strisce LED**  
Diffusorprofil rund für LED Streifen



Lunghezza/Längengrad	Finitura/Fertigstellung	Imballaggio/Verpackung	Cod.
2,35 m	Plastica bianca/Weißer Kunststoff	20 UN/Einh	5147015
2,9 m	Plastica bianca/Weißer Kunststoff	20 UN/Einh	5147215

Tecnoplastica/Kunststoff

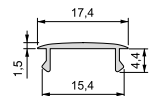

**Profilo da incasso per strisce LED**  
Profil zum Einbauen für LED Streifen



Lunghezza/Längengrad	Finitura/Fertigstellung	Imballaggio/Verpackung	Cod.
2,35 m	Anodizzato opaco/Matt eloxiert	20 UN/Einh	5085162
2,9 m	Anodizzato opaco/Matt eloxiert	20 UN/Einh	5085462

Alluminio/Aluminium

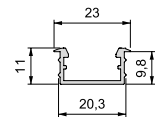

**Accessorio per incasso in profilo di alluminio del diffusore curvo**  
Zubehör für Einbau in Aluminiumprofil das gebogene Diffusorprofil



Finitura/Fertigstellung	Imballaggio/Verpackung	Cod.
Plastica grigia/Crau	20 UN/Einh	5144221

Tecnoplastica/Kunststoff

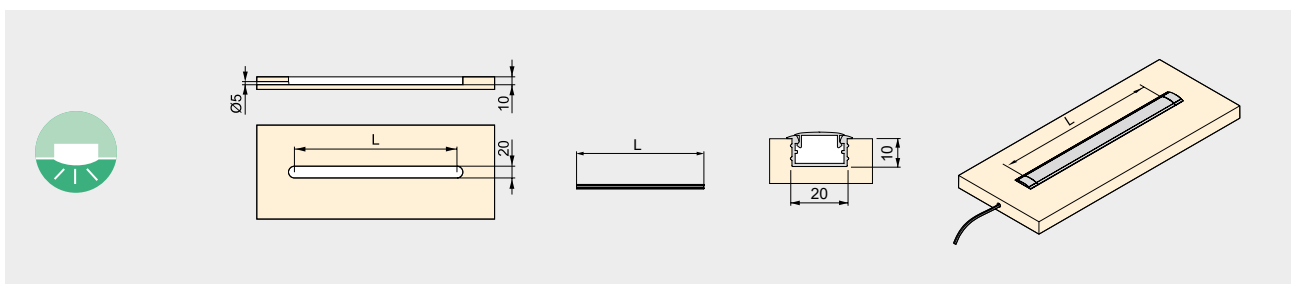
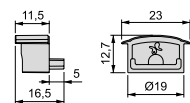

**Profilo diffusore curvo per strisce LED**  
**Diffusorprofil rund für LED Streifen**



Lunghezza/Längengrad	Finitura/Fertigstellung	Imballaggio/Verpackung	Cod.
2,35 m	Plastica bianca/Weißer Kunststoff	20 UN/Einh	5147015
2,9 m	Plastica bianca/Weißer Kunststoff	20 UN/Einh	5147215

Tecnoplastica/Kunststoff

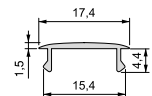

**Profilo per montaggio a superficie per strisce LED**  
**Profil für Oberflächen für LED Streifen**



Lunghezza/Längengrad	Finitura/Fertigstellung	Imballaggio/Verpackung	Cod.
2,35 m	Anodizzato opaco/Matt eloxiert	20 UN/Einh	5085062

Alluminio/Aluminium

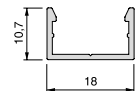
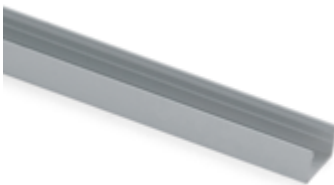

**Accessori per montaggio a superficie**  
**Zubehör für Aufputzprofil**



Finitura/Fertigstellung	Imballaggio/Verpackung	Cod.
Plastica grigia/Crau	10 UN/Einh	5143421

Tecnoplastica/Kunststoff

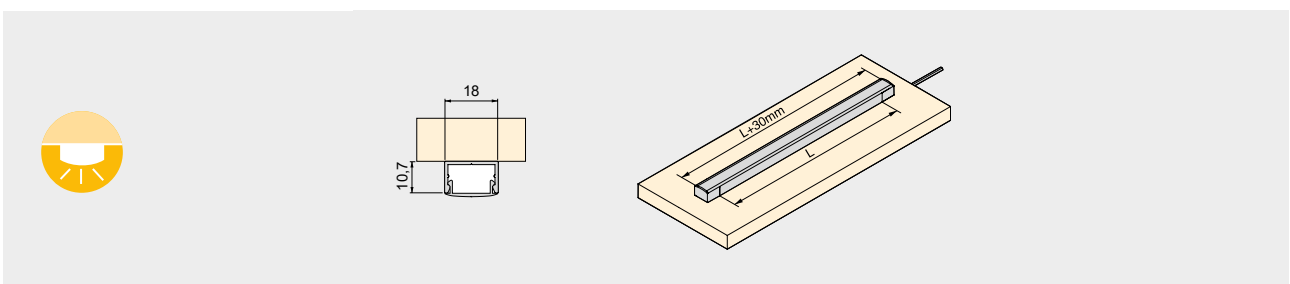
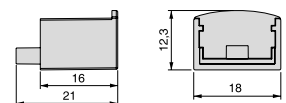

Profilo diffusore curvo per strisce LED  
 Diffusorprofil rund für LED Streifen



Lunghezza/Längengrad	Finitura/Fertigstellung	Imballaggio/Verpackung	Cod.
2,35 m	Plastica bianca/Weißer Kunststoff	20 UN/Einh	5147015
2,9 m	Plastica bianca/Weißer Kunststoff	20 UN/Einh	5147215

Tecnoplastica/Kunststoff

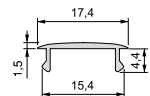

Profilo inclinato a superficie per strisce LED  
 Geneigtes Oberflächenprofil für LED-Streifen



Lunghezza/Längengrad	Finitura/Fertigstellung	Imballaggio/Verpackung	Cod.
2,35 m	Anodizzato opaco/Matt eloxiert	20 UN/Einh	5085362
2,9 m	Anodizzato opaco/Matt eloxiert	20 UN/Einh	5085662

Alluminio/Aluminium

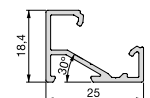

Accessori per profilo inclinato  
 Zubehör für geneigtes Oberflächenprofil



Finitura/Fertigstellung	Imballaggio/Verpackung	Cod.
Plastica grigia/Grau	10 UN/Einh	5146321

Tecnoplastica/Kunststoff

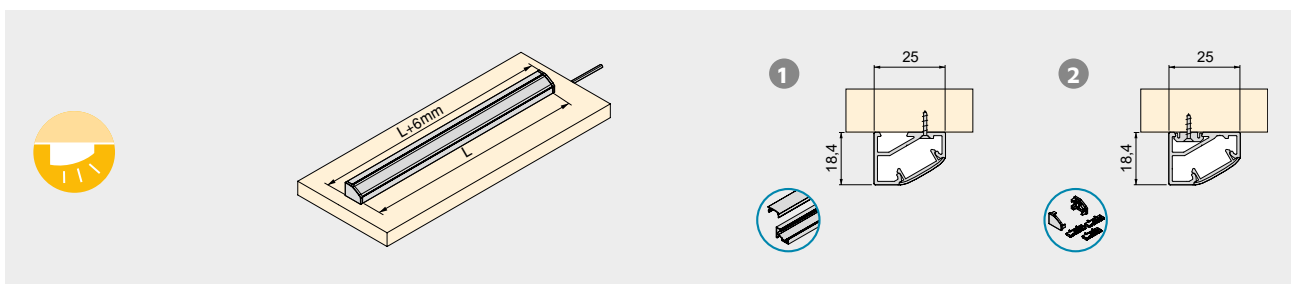
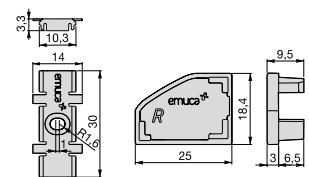

Profili Lynx da incasso per strisce LED  
 Lynx Profile für LED-Einbauleuchten



Lunghezza/Längengrad	Finitura/Fertigstellung	Imballaggio/Verpackung	Cod.
2,35 m	Anodizzato opaco/Matt eloxiert	8 UN/Einh	5148662

Alluminio/Aluminium

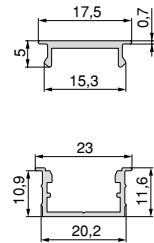
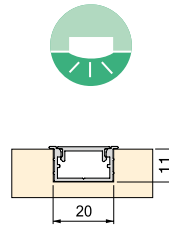

Profili Lynx per montaggio a superficie per strisce LED  
 Lynx Unterbauprofile für LED Streifen



Lunghezza/Längengrad	Finitura/Fertigstellung	Imballaggio/Verpackung	Cod.
2,35 m	Anodizzato opaco/Matt eloxiert	8 UN/Einh	5148762

Alluminio/Aluminium

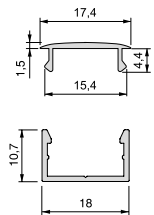
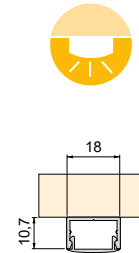
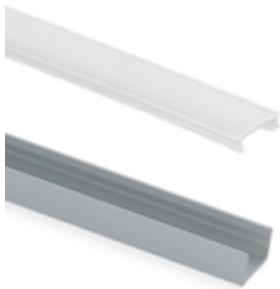

Profili Lynx inclinati a superficie per strisce LED  
 Lynx-geneigte Oberflächenprofile für LED-Streifen



Lunghezza/Längengrad	Finitura/Fertigstellung	Imballaggio/Verpackung	Cod.
2,35 m	Anodizzato opaco/Matt eloxiert	6 UN/Einh	5148862

Alluminio/Aluminium

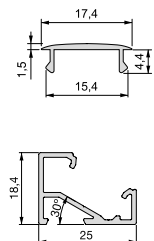
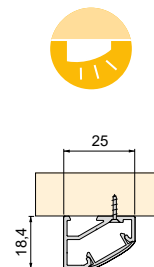
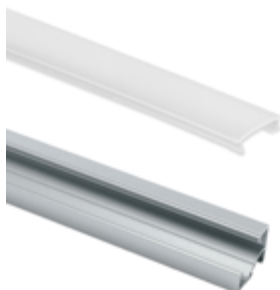



## Illuminazione per cassetti Schubladen-Leuchten

Taika è un apparecchio LED longitudinale dall'elegante design compatto per illuminare l'interno di cassetti o armadi.

Taika ist eine LED-Längsleuchte mit elegantem, kompaktem Design für die Beleuchtung der Innenseite von Schubladen oder Schränken.



12V DC

6W	5211020
15W	5211120
30W	5147420
50W	5147520
72W	5008520
100W	5209320
200W	5209420

È adatto all'installazione in moduli di 500, 600, 800 e 900 mm di larghezza con uno spessore del pannello da 16 a 19 mm, a seconda del modello scelto.

Sie eignet sich für den Einbau in 500, 600, 800 und 900 mm breite Module mit einer Plattenstärke von 16 bis 19 mm, je nach gewähltem Modell.



16 mm



18 mm



19 mm

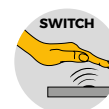
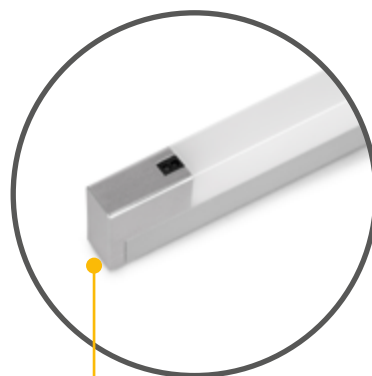

SWITCH

È dotato di un sensore di prossimità integrato, che accende l'apparecchio quando il cassetto viene aperto e lo spegne quando viene chiuso.

Sie verfügt über einen integrierten Näherungssensor, der die Leuchte beim Öffnen der Schublade einschaltet und beim Schließen ausschaltet.

Luminaria LED Taika per cassetto (12V DC)

Taika LED-Schubladenleuchte (12V DC)

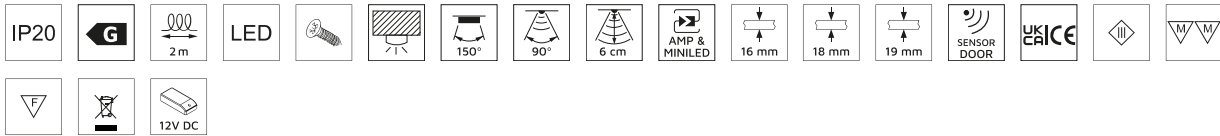

M	L	Lumen	Potenza/Leistung	Temperatura di colore/ Farbtemperatur	Finitura/Fertigstellung	Imballaggio/Ver- packung	Cod.
500	462-468	225 lm	4,1 W	Bianco naturale 4.000 K/ Naturweiß 4.000 K	Anodizzato opaco/ Matt eloxiert	1 UN/Einh	5216062
600	562-568	282 lm	5,2 W	Bianco naturale 4.000 K/ Naturweiß 4.000 K	Anodizzato opaco/ Matt eloxiert	1 UN/Einh	5216162
800	762-768	360 lm	6,6 W	Bianco naturale 4.000 K/ Naturweiß 4.000 K	Anodizzato opaco/ Matt eloxiert	1 UN/Einh	5216262
900	862-868	415 lm	7,5 W	Bianco naturale 4.000 K/ Naturweiß 4.000 K	Anodizzato opaco/ Matt eloxiert	1 UN/Einh	5216362

Alluminio, Tecnoplastica/  
Aluminium, Kunststoff

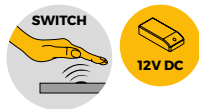

	500	600	800	900
0,25 m	476 lx	597 lx	762 lx	878 lx
0,50 m	173 lx	217 lx	277 lx	319 lx
0,75 m	82 lx	103 lx	132 lx	152 lx
1,00 m	52 lx	65 lx	83 lx	96 lx
1,25 m	35 lx	43 lx	55 lx	64 lx

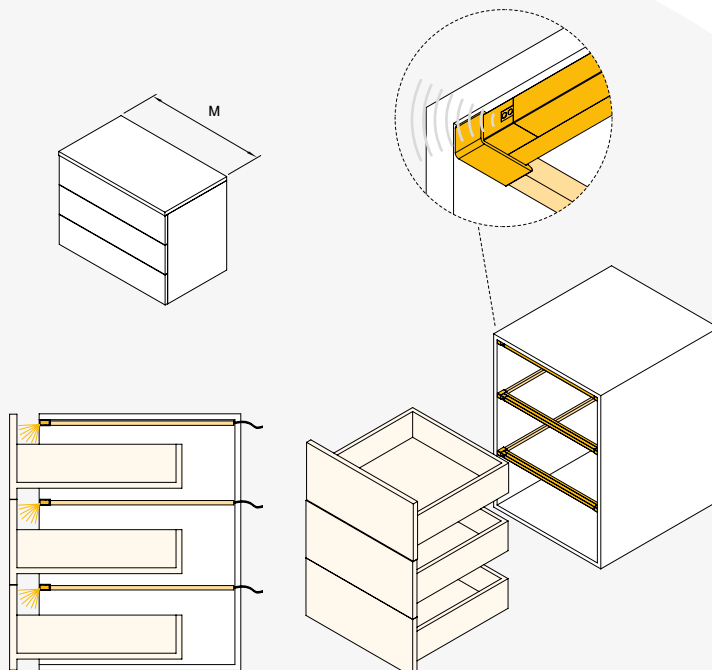
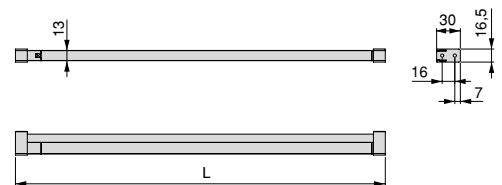

Per l'installazione, le staffe vengono avvitate ai lati del modulo dove viene fissato l'apparecchio. Sul lato del modulo viene fissato con nastro biadesivo il profilo passacavo da 500 mm, attraverso il quale il cavo viene fatto passare sul retro per evitare che interferisca con il movimento del cassetto.

Zur Montage werden die Halterungen an den Seiten des Moduls angeschraubt, an denen die Leuchte befestigt wird. An der Seite des Moduls wird das 500 mm lange Kabeleinführungsprofil mit doppelseitigem Klebeband befestigt, durch das das Kabel nach hinten geführt wird, damit es die Bewegung des Schubkastens nicht behindert.

## Specchi illuminati Beleuchtete Spiegel

Sono la migliore soluzione funzionale e decorativa per illuminare il bagno o qualsiasi altra stanza, offrendo un'illuminazione uniforme e priva di ombre che facilita la visibilità.

Sie sind die beste funktionelle und dekorative Lösung für die Beleuchtung Ihres Badezimmers oder jedes anderen Raums und bieten eine gleichmäßige, schattenfreie Beleuchtung, die die Sichtbarkeit erleichtert.

AC 230V  
50Hz



Sono confezionati in un imballaggio speciale ed esclusivo per evitare qualsiasi rottura, che elimina efficacemente il rischio di danneggiare il prodotto durante il trasporto.

Sie sind in einer speziellen und exklusiven Verpackung verpackt, um jeden Bruch zu vermeiden, was das Risiko einer Beschädigung des Produkts während des Transports effektiv eliminiert.



Sono resistenti all'umidità e agli spruzzi d'acqua grazie al grado di protezione IP44.

IP44

Dank der Schutzart IP44 sind sie feuchtigkeits- und spritzwasserbeständig.

Si distinguono per la facilità di installazione, in quanto includono tutti gli elementi necessari per il montaggio.

Sie zeichnen sich durch eine einfache Installation aus, da sie alle notwendigen Elemente für die Montage enthalten.



Specchio Cepheus con illuminazione LED decorativa (AC 230V 50Hz)  
Spiegel Cepheus mit LED Beleuchtung (AC 230V 50Hz)



Lumen	Potenza/Leistung	Temperatura di colore/ Farbtemperatur	LEDs	Finitura/Fertigstellung	Imballaggio/Verpackung	Cod.
882 lm	12 W	Bianco naturale 4.000 K/ Naturweiß 4.000 K	129	Non classificata/Nicht bestimmt	1 UN/Einh	5150920

Alluminio, Vetro/Aluminium, Glas



Specchio con retroilluminazione LED integrata, installabile sia in verticale che in orizzontale.

Spiegel mit integrierter LED-Hintergrundbeleuchtung, der sowohl vertikal als auch horizontal installiert werden kann.

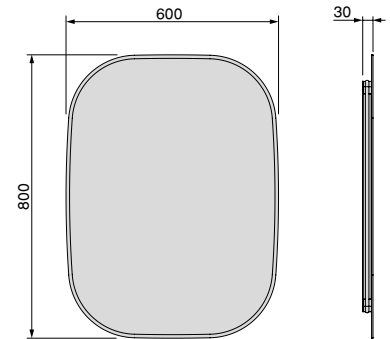

Specchio Zeus con illuminazione LED decorativa (AC 230V 50Hz)  
Spiegel Zeus mit LED Beleuchtung (AC 230V 50Hz)



Lumen	Potenza/Leistung	Temperatura di colore/ Farbtemperatur	LEDs	Finitura/Fertigstellung	Imballaggio/Verpackung	Cod.
850 lm	12 W	Bianco naturale 4.000 K/ Naturweiß 4.000 K	126	Non classificata/Nicht bestimmt	1 UN/Einh	5150820

Alluminio, Vetro/Aluminium, Glas

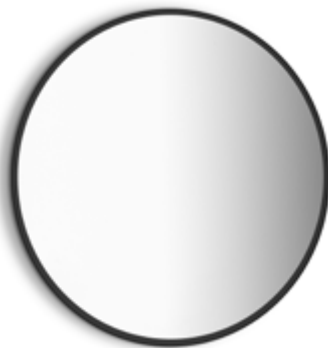

Specchio con retroilluminazione a LED integrata.

Spiegel mit integrierter LED-Hintergrundbeleuchtung.

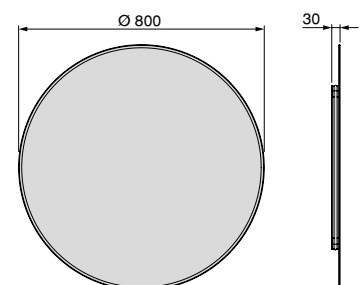

Specchio Centaurus con illuminazione LED decorativa (AC 230V 50Hz)  
Spiegel Centaurus mit LED Beleuchtung (AC 230V 50Hz)



Lumen	Potenza/Leistung	Temperatura di colore/ Farbtemperatur	LEDs	Finitura/Fertigstellung	Imballaggio/Verpackung	Cod.
890 lm	14 W	Bianco naturale 4.000 K/ Naturweiß 4.000 K	147	Non classificata/Nicht bestimmt	1 UN/Einh	5150720

Alluminio, Vetro/Aluminium, Glas



Specchio con retroilluminazione a LED integrata, installabile sia in verticale che in orizzontale.

Spiegel mit integrierter LED-Hintergrundbeleuchtung, der sowohl senkrecht als auch waagrecht montiert werden kann.

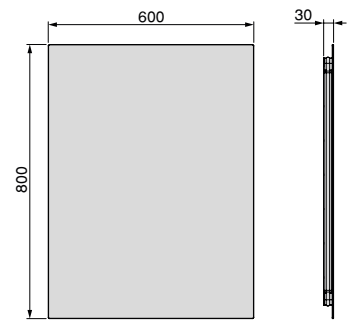

Specchio da bagno Cassiopea con illuminazione LED decorativa  
Spiegel Cassiopeia mit LED Beleuchtung (AC 230V 50Hz)



Lumen	Potenza/Leistung	Temperatura di colore/ Farbtemperatur	Finitura/Fertigstellung	Imballaggio/Verpackung	Cod.
718 lm	20 W + 12 W	Bianco naturale 4.000 K/ Naturweiß 4.000 K	Non classificata/Nicht bestimmt	1 UN/Einh	5148220



Alluminio, Vetro/Aluminium, Glas

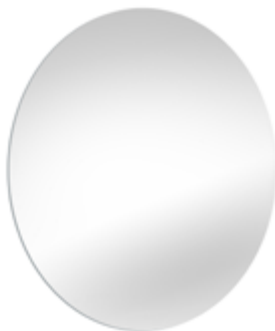

Specchio con retroilluminazione a LED e sistema antiappannamento che impedisce allo specchio di appannarsi, ottenendo così uno specchio sempre pulito.

Spiegel mit LED-Hintergrundbeleuchtung und Anti-Beschlag-System, das ein Beschlagen des Spiegels verhindert und somit einen stets sauberen Spiegel gewährleistet.

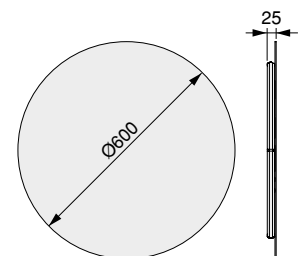

Specchio da bagno Heracles con illuminazione LED frontale e decorativa  
Heracles Badspiegel mit LED-Front und dekorativer Beleuchtung (AC 230V 50Hz)



Lumen	Potenza/Leistung	Temperatura di colore/ Farbtemperatur	Finitura/Fertigstellung	Imballaggio/Verpackung	Cod.
1.728 lm	11 W + 12 W	Bianco naturale 4.000 K/ Naturweiß 4.000 K	Non classificata/Nicht bestimmt	1 UN/Einh	5151020

Tecnoplastica, Vetro/Kunststoff, Glas



Specchio con luce LED frontale e retroilluminazione. È dotato di un interruttore a sfioramento integrato che accende la luce e attiva il sistema antiappannamento.

Spiegel mit LED-Frontleuchte und Hintergrundbeleuchtung. Er verfügt über einen integrierten Berührungsschalter, der das Licht einschaltet und das Anti-Beschlag-System aktiviert.

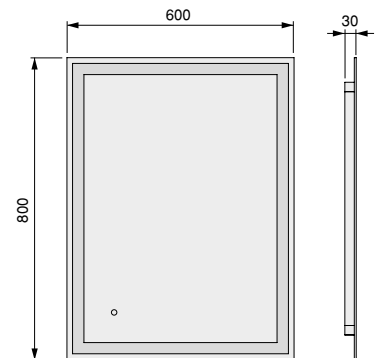

Specchio da bagno Pegasus con illuminazione LED frontale  
Spiegel Pegasus mit LED Beleuchtung (AC 230V 50Hz)



Lumen	Potenza/Leistung	Temperatura di colore/ Farbtemperatur	Finitura/Fertigstellung	Imballaggio/Verpackung	Cod.
414 lm	6 W	Bianco naturale 4.000 K/ Naturweiß 4.000 K	Non classificata/Nicht bestimmt	1 UN/Einh	5148120

Alluminio, Vetro/Aluminium, Glas



Specchio con luce LED anteriore e trattamento anticorrosione che impedisce allo specchio di arrugginire sui bordi.

Spiegel mit LED-Frontleuchte und Antikorrosionsbehandlung, die das Rosten des Spiegels an den Rändern verhindert.

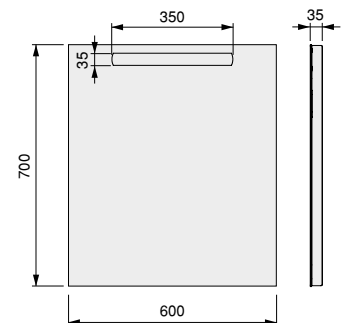

## Illuminazioni da bagno Badezimmerleuchten

Sono progettati per illuminare l'area dello specchio, in quanto proiettano la luce verso il viso, fornendo un'illuminazione uniforme e non abbagliante.

Sie sind so konzipiert, dass sie den Spiegelbereich beleuchten, da sie das Licht auf das Gesicht projizieren und so eine gleichmäßige, blendfreie Ausleuchtung bieten.

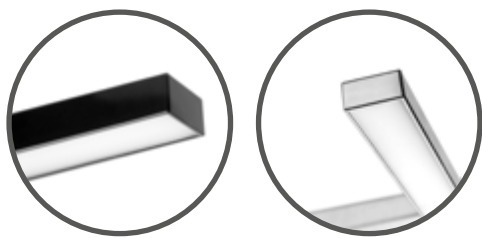

Dispongono della più recente tecnologia dei sistemi di illuminazione a LED e non necessitano di trasformatore di alimentazione perché funzionano a 230V CA.

Sie verfügen über die neueste Technologie der LED-Beleuchtungssysteme und benötigen keinen Transformator, da sie mit 230 V Wechselstrom betrieben werden.

AC 230V  
50Hz

Sono resistenti all'umidità e agli spruzzi d'acqua grazie al grado di protezione IP44.

IP44

Dank der Schutzart IP44 sind sie feuchtigkeits- und spritzwassergeschützt.

Si distinguono per la facilità di installazione, in quanto dispongono di un gancio per il montaggio su vetro, lavagna o sulla superficie dei mobili, con viti incluse.

Sie zeichnen sich durch eine einfache Installation aus, da sie über einen Haken zur Befestigung an Glas, Platten oder an der Oberfläche von Möbeln verfügen, wobei Schrauben im Lieferumfang enthalten sind.

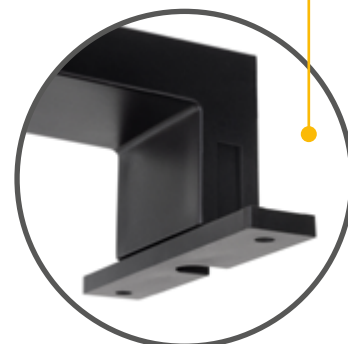

Faretto LED per specchio da bagno Leo (AC 230V 50Hz)

Leo LED-Badezimmer-Spiegelleuchte (AC 230V 50Hz)



Lumen	Potenza/Leistung	Temperatura di colore/ Farbtemperatur	LEDs	Finitura/Fertigstellung	Imballaggio/Verpackung	Cod.
457 lm	6 W	Bianco freddo 5.700 K/ Kaltweiß 5.700 K	60	Verniciato nero/ Schwarz	5 UN/Einh	5150114

Tecnoplastica/Kunststoff

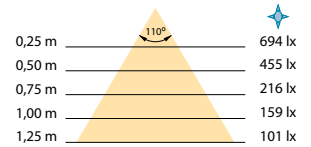

Faretto LED per specchio da bagno Virgo (AC 230V 50Hz)

Virgo LED-Spiegelstrahler für das Badezimmer (AC 230V 50Hz)

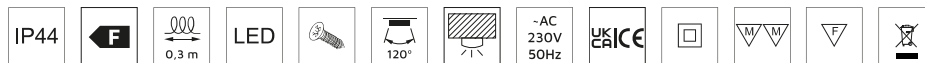

Lumen	Potenza/Leistung	Temperatura di colore/ Farbtemperatur	LEDs	Finitura/Fertigstellung	Imballaggio/Verpackung	Cod.
400 lm	6 W	Bianco freddo 6.000 K/ Kaltweiß 6.000 K	60	Cromato lucido/ Verchromt	5 UN/Einh	5149111
400 lm	6 W	Bianco freddo 6.000 K/ Kaltweiß 6.000 K	60	Verniciato nero/ Schwarz	5 UN/Einh	5149114

Tecnoplastica/Kunststoff

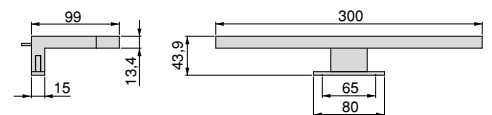
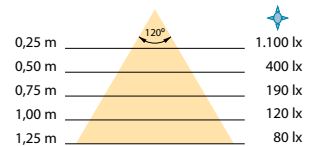



Faretto LED per specchio da bagno Gemini (AC 230V 50Hz)  
 Gemini LED-Spiegelstrahler für das Badezimmer (AC 230V 50Hz)



Lumen	Potenza/Leistung	Temperatura di colore/ Farbtemperatur	Finitura/Fertigstellung	Imballaggio/Verpackung	Cod.
392 lm	6 W	Bianco naturale 4.000 K/ Naturweiß 4.000 K	Cromato lucido/Verchromt	5 UN/Einh	5150011
392 lm	6 W	Bianco naturale 4.000 K/ Naturweiß 4.000 K	Verniciato nero/Schwarz	5 UN/Einh	5150014

Alluminio, Tecnoplastica/Aluminium, Kunststoff

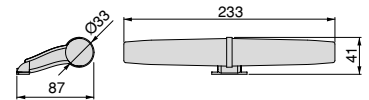
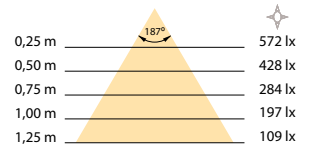

Si distinguono per la facilità di installazione in quanto includono tutti gli elementi necessari per il montaggio.

Sie zeichnen sich durch ihre einfache Installation aus, da sie alle notwendigen Elemente für die Montage enthalten.

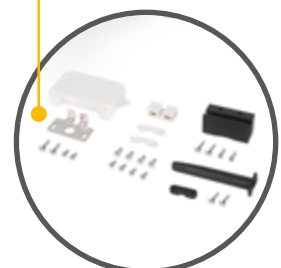

Faretto LED per specchio da bagno Aries (AC 230V 50Hz)

Aries LED-Spiegelstrahler für das Badezimmer (AC 230V 50Hz)



Lumen	Potenza/Leistung	Temperatura di colore/ Farbtemperatur	Finitura/Fertigstellung	Imballaggio/Verpackung	Cod.
599 lm	7 W	Bianco freddo 5.700 K/ Kaltweiß 5.700 K	Cromato lucido/Verchromt	5 UN/Einh	5150211

Alluminio, Tecnoplastica/Aluminium, Kunststoff

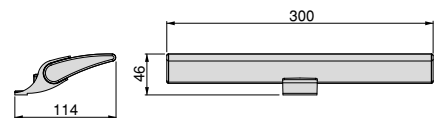

Applique LED per specchio da bagno Aquarius 300 - 450 mm

LED-Einbauleuchte für Badmöbelspiegel Aquarius 300 - 450 mm (AC 230V 50Hz)

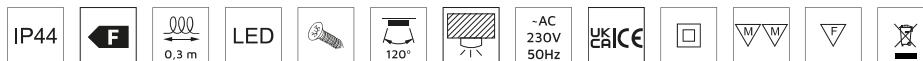

A	Lumen	Potenza/Leistung	Temperatura di colore/ Farbtemperatur	LEDs	Finitura/Fertigstellung	Imballaggio/Verpackung	Cod.
300	520 lm	7 W	Bianco freddo 6.000 K/ Kaltweiß 6.000 K	60	Cromato lucido/ Verchromt	5 UN/Einh	5145311
450	480 lm	7 W	Bianco freddo 6.000 K/ Kaltweiß 6.000 K	60	Cromato lucido/ Verchromt	5 UN/Einh	5145411

Alluminio, Tecnoplastica/Aluminium, Kunststoff

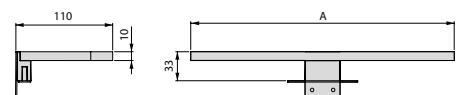

## Batteria Mit Batterie

Gli apparecchi a batteria ricaricabili consentono di illuminare cucine e armadi, senza bisogno di cablaggi o installazioni complicate.

Wiederaufladbare, batteriebetriebene Leuchten ermöglichen die Beleuchtung in Küchen und Schränken, ohne dass eine Verkabelung oder komplizierte Installation erforderlich ist.

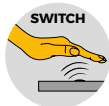

Sistema di rilevamento di prossimità che accende o spegne l'apparecchio quando il suo campo di rilevamento è disturbato.

Annäherungserkennungssystem, das die Leuchte ein- oder ausschaltet, wenn ihr Erfassungsbereich beeinträchtigt wird.



Sistema di rilevamento del movimento che accende l'apparecchio quando il suo raggio di rilevamento viene disturbato.

Bewegungserkennungssystem, das die Leuchte ein- und ausschaltet, wenn ihr Erfassungsbereich beeinträchtigt wird.

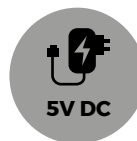

Batteria ricaricabile ai polimeri di litio che può essere ricaricata con un comune caricabatterie per cellulari da 5 V DC.

Wiederaufladbarer Lithium-Polymer-Akku, der mit einem herkömmlichen 5-V-Gleichstrom-Handy-Ladegerät aufgeladen werden kann.

Applique LED Kaus Black ricaricabile via USB con sensore di movimento  
LED-Einbauleuchte Kaus Black USB Aufladbar mit Bewegungssensor



L	Lumen	Potenza/Leistung	Temperatura di colore/ Farbtemperatur	Finitura/Fertigstellung	Imballaggio/Verpackung	Cod.
240	60 lm	1 W	Bianco naturale 4.000 K/ Naturweiß 4.000 K	Verniciato nero/ Schwarz	1 UN/Einh	5214114
400	120 lm	2 W	Bianco naturale 4.000 K/ Naturweiß 4.000 K	Verniciato nero/ Schwarz	1 UN/Einh	5214214
600	180 lm	3 W	Bianco naturale 4.000 K/ Naturweiß 4.000 K	Verniciato nero/ Schwarz	1 UN/Einh	5214314

Alluminio, Tecnoplastica/Aluminium, Kunststoff

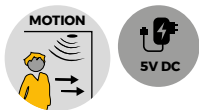

	240 mm	400 mm	600 mm
0,25 m	368 lx	610 lx	855 lx
0,50 m	105 lx	234 lx	286 lx
0,75 m	49 lx	117 lx	135 lx
1,00 m	28 lx	70 lx	78 lx
1,25 m	18 lx	45 lx	50 lx

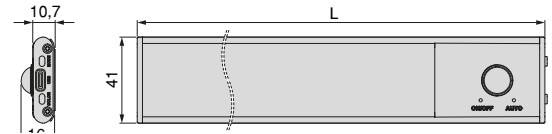

Applique LED Kaus Black ricaricabile via USB con sensore di prossimità  
Sistema de iluminação LED recarregável por USB Kaus Black com sensor de proximidade



L	Lumen	Potenza/Leistung	Temperatura di colore/ Farbtemperatur	Finitura/Fertigstellung	Imballaggio/Verpackung	Cod.
240	60 lm	1 W	Bianco naturale 4.000 K/ Naturweiß 4.000 K	Verniciato nero/ Schwarz	1 UN/Einh	5214414
400	120 lm	2 W	Bianco naturale 4.000 K/ Naturweiß 4.000 K	Verniciato nero/ Schwarz	1 UN/Einh	5214514
600	180 lm	3 W	Bianco naturale 4.000 K/ Naturweiß 4.000 K	Verniciato nero/ Schwarz	1 UN/Einh	5214614

Alluminio, Tecnoplastica/Aluminium, Kunststoff

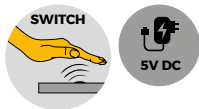

	240 mm	400 mm	600 mm
0,25 m	368 lx	610 lx	855 lx
0,50 m	105 lx	234 lx	286 lx
0,75 m	49 lx	117 lx	135 lx
1,00 m	28 lx	70 lx	78 lx
1,25 m	18 lx	45 lx	50 lx

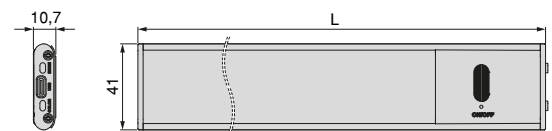

Applique LED Kaus ricaricabile via USB con sensore di movimento  
LED-Einbauleuchte Kaus USB Aufladbar mit Bewegungssensor



L	Lumen	Potenza/Leistung	Temperatura di colore/ Farbtemperatur	Finitura/Fertigstellung	Imballaggio/ Verpackung	Cod.
240	60 lm	1 W	3.000 K - 4.000 K - 6.000 K	Anodizzato opaco/ Matt eloxiert	1 UN/Einh	5213462
400	120 lm	2 W	3.000 K - 4.000 K - 6.000 K	Anodizzato opaco/ Matt eloxiert	1 UN/Einh	5213562
600	180 lm	3 W	3.000 K - 4.000 K - 6.000 K	Anodizzato opaco/ Matt eloxiert	1 UN/Einh	5213662

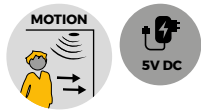

Cavo di ricarica USB-C da 30 cm incluso.  
30 cm USB-C-Ladekabel im Lieferumfang enthalten.

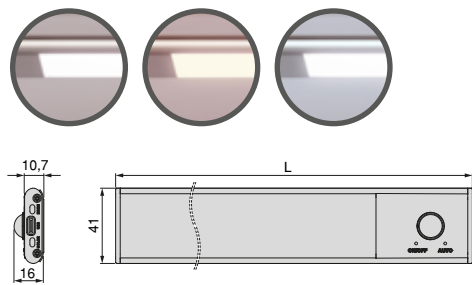

Alluminio, Tecnoplastica/Aluminium, Kunststoff

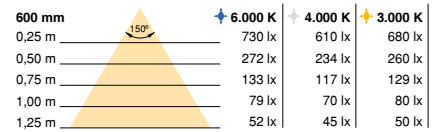
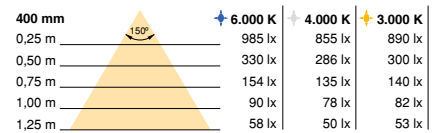
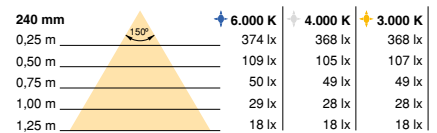

Applique LED Kaus ricaricabile via USB con sensore tattile di prossimità  
LED-Einbauleuchte Kaus USB Aufladbar mit switch



L	Lumen	Potenza/Leistung	Temperatura di colore/ Farbtemperatur	Finitura/Fertigstellung	Imballaggio/ Verpackung	Cod.
240	60 lm	1 W	3.000 K - 4.000 K - 6.000 K	Anodizzato opaco/ Matt eloxiert	1 UN/Einh	5213762
400	120 lm	2 W	3.000 K - 4.000 K - 6.000 K	Anodizzato opaco/ Matt eloxiert	1 UN/Einh	5213862
600	180 lm	3 W	3.000 K - 4.000 K - 6.000 K	Anodizzato opaco/ Matt eloxiert	1 UN/Einh	5213962

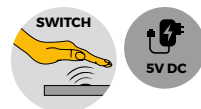

Cavo di ricarica USB-C da 30 cm incluso.  
30 cm USB-C-Ladekabel im Lieferumfang enthalten.

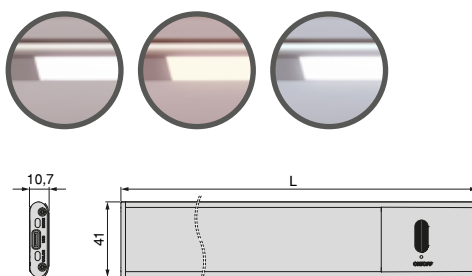

Alluminio, Tecnoplastica/Aluminium, Kunststoff

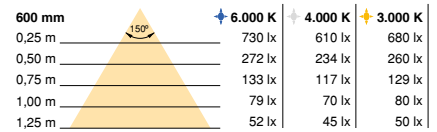
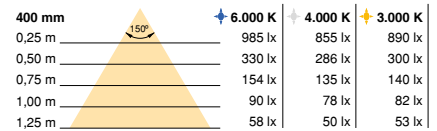
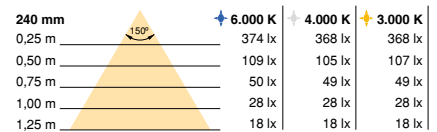

Luce LED Rigel ricaricabile via USB per l'interno dei cassetti con sensore di vibrazione  
Batteriebetriebenes LED-Licht Rigel für Schubladen mit Schwingungssensor und kaltem Licht

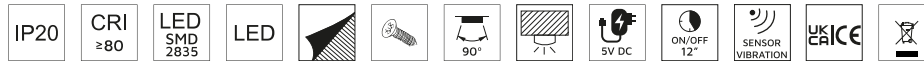

Lumen	Potenza/Leistung	Temperatura di colore/ Farbtemperatur	LEDs	Finitura/Fertigstellung	Imballaggio/Verpackung	Cod.
75 lm	1 W	Bianco naturale 4.000 K/ Naturweiß 4.000 K	10	Verniciato alluminio/ Grau metallic	5 UN/Einh	5214025

Tecnoplastica/Kunststoff

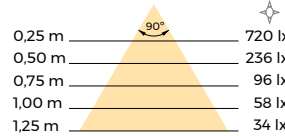
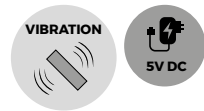

È dotato di un sensore che rileva la vibrazione del cassetto quando viene aperto e accende l'apparecchio.

Sie verfügt über einen Sensor, der die Vibration der Schublade beim Öffnen erkennt und die Leuchte einschaltet.

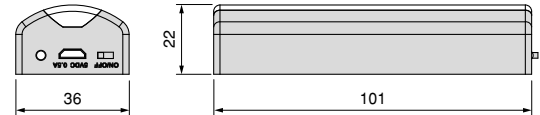

Luminaria LED ricaricabile Kraz con sensore di movimento  
Kraz aufladbare Leuchte mit Bewegungssensor



Lumen	Potenza/Leistung	Temperatura di colore/ Farbtemperatur	LEDs	Finitura/Fertigstellung	Imballaggio/Verpackung	Cod.
85 lm	1 W	Bianco naturale 4.000 K/ Naturweiß 4.000 K	9	Verniciato alluminio/ Grau metallic	5 UN/Einh	5028625

Tecnoplastica/Kunststoff

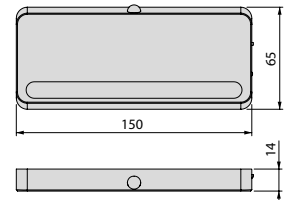
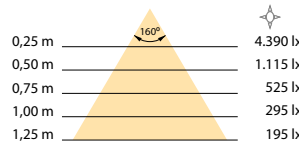
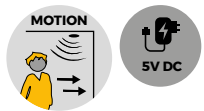

Luminaria LED Crater ricaricabile tramite usb e con sensore di movimento  
LED-Einbauleuchte Crater USB Aufladbar mit Bewegungssensor



Lumen	Potenza/Leistung	Temperatura di colore/ Farbtemperatur	LEDs	Finitura/Fertigstellung	Imballaggio/Verpackung	Cod.
110 lm	1 W	Bianco naturale 4.000 K/ Naturweiß 4.000 K	28	Verniciato alluminio/ Grau metallic	5 UN/Einh	5023925

Tecnoplastica/Kunststoff

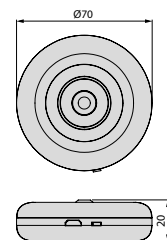
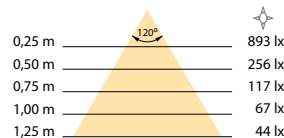
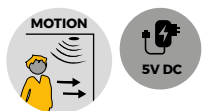

## Barra pensile con illuminazione Beleuchtete Hängestangen

Sono ideali per illuminare l'interno dei vostri armadi o spogliatoi con un design elegante, pratico e funzionale.

Sie sind ideal für die Innenbeleuchtung Ihrer Schränke oder Umkleidekabinen mit einem eleganten, praktischen und funktionellen Design.



Sistema di rilevamento del movimento che accende l'apparecchio quando il suo campo di rilevamento viene disturbato.

Bewegungserkennungssystem, das die Leuchte einschaltet, wenn ihr Erfassungsbereich beeinträchtigt wird.



### Barra appendibili per armadi Polux con luce LED con sensore di movimento Schrankstange mit LED Beleuchtung Polux und Bewegungssensor (12V DC)

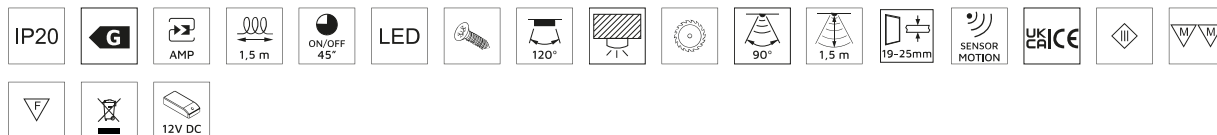

A	L	Taglio/Schnitt	Lumen	Potenza/Leistung	Temperatura di colore/Farbtemperatur	LEDs	Finitura/Fertigstellung	Imballaggio/Verpackung	Cod.
558	547	408-558	125 lm	2,6 W	Bianco naturale 4.000 K/Naturweiß 4.000 K	32	Anodizzato opaco/Matt eloxiert	1 UN/Einh	5074562
708	697	558-708	160 lm	3,3 W	Bianco naturale 4.000 K/Naturweiß 4.000 K	41	Anodizzato opaco/Matt eloxiert	1 UN/Einh	5074662
858	847	708-858	190 lm	4 W	Bianco naturale 4.000 K/Naturweiß 4.000 K	50	Anodizzato opaco/Matt eloxiert	1 UN/Einh	5074762
1.008	997	858-1.008	230 lm	4,8 W	Bianco naturale 4.000 K/Naturweiß 4.000 K	59	Anodizzato opaco/Matt eloxiert	1 UN/Einh	5074862
1.158	1.147	1.008-1.158	260 lm	5,5 W	Bianco naturale 4.000 K/Naturweiß 4.000 K	68	Anodizzato opaco/Matt eloxiert	1 UN/Einh	5074962

Alluminio, Tecnoplastica/Aluminium, Kunststoff

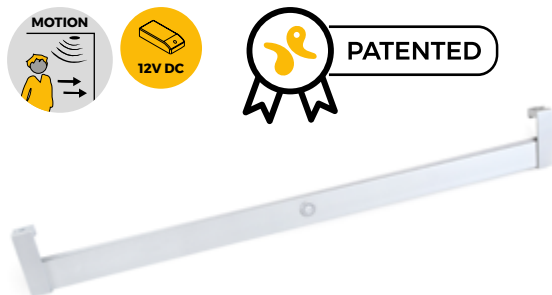

$L = A - 11 \text{ mm}$

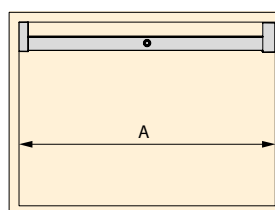

Distance (m)	Illuminance (lx/m)
0,25	1.100
0,50	440
0,75	240
1,00	150
1,25	100

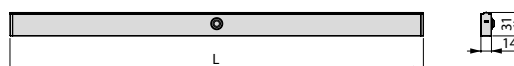

Il cod. 5077962 è compreso il reggitubo centrale.  
Non include il convertitore LED.

Der cod. 5077962 umfasst die zentrale Schienenstütze.  
Enthält keinen LED-Konverter.

Barra appendibili per armadi Castor con luce LED, batteria rimovibile e sensore di movimento  
 Schrankstange mit LED Beleuchtung Castor, USB aufladbar und Bewegungssensor



A	L	Taglio/Schnitt	Lumen	Potenza/Leistung	Temperatura di colore/Farbtemperatur	LEDs	Finitura/Fertigstellung	Imballaggio/Verpackung	Cod.
558	547	408-558	30 lm	0,6 W	Bianco naturale 4.000 K/Naturweiß 4.000 K	30	Verniciato moka/Mokka	1 UN/Einh	5074013
708	697	558-708	35 lm	0,7 W	Bianco naturale 4.000 K/Naturweiß 4.000 K	45	Verniciato moka/Mokka	1 UN/Einh	5074113
858	847	708-858	45 lm	0,9 W	Bianco naturale 4.000 K/Naturweiß 4.000 K	60	Verniciato moka/Mokka	1 UN/Einh	5074213
1.008	997	858-1.008	50 lm	1 W	Bianco naturale 4.000 K/Naturweiß 4.000 K	75	Verniciato moka/Mokka	1 UN/Einh	5074313
1.158	1.147	1.008-1.158	55 lm	1,2 W	Bianco naturale 4.000 K/Naturweiß 4.000 K	90	Verniciato moka/Mokka	1 UN/Einh	5074413
558	547	408-558	30 lm	0,6 W	Bianco naturale 4.000 K/Naturweiß 4.000 K	30	Anodizzato opaco/Matt eloxiert	1 UN/Einh	5074062
708	697	558-708	35 lm	0,7 W	Bianco naturale 4.000 K/Naturweiß 4.000 K	45	Anodizzato opaco/Matt eloxiert	1 UN/Einh	5074162
858	847	708-858	45 lm	0,9 W	Bianco naturale 4.000 K/Naturweiß 4.000 K	60	Anodizzato opaco/Matt eloxiert	1 UN/Einh	5074262
1.008	997	858-1.008	50 lm	1 W	Bianco naturale 4.000 K/Naturweiß 4.000 K	75	Anodizzato opaco/Matt eloxiert	1 UN/Einh	5074362
1.158	1.147	1.008-1.158	55 lm	1,2 W	Bianco naturale 4.000 K/Naturweiß 4.000 K	90	Anodizzato opaco/Matt eloxiert	1 UN/Einh	5074462

Alluminio, Tecnoplastica/  
 Aluminium, Kunststoff



L = A - 11 mm

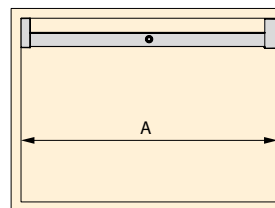

0,25 m	240 lx/m
0,50 m	100 lx/m
0,75 m	55 lx/m
1,00 m	35 lx/m
1,25 m	25 lx/m

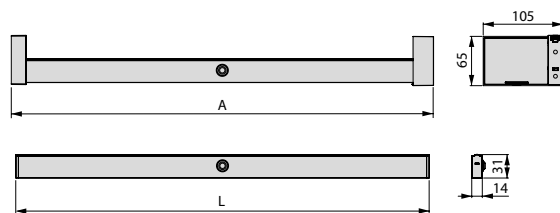

Funzionamento con batteria rimovibile, che pu essere ricaricata da un caricabatterie mobile 5V DC 1A con spina micro USB tipo B.  
 Nel cod. 5077413 e 5077462 è compreso il reggitubo centrale.

Funktioniert mit einem herausnehmbaren Akku, der mit einem mobilen 5 VDC 1A Ladegerät mit einem micro USB type B Anschluss aufgeladen werden kann.  
 Der Kabeljau. 5077413 und 5077462 enthielten die zentrale Schienenhalterung.



# Lampade Beleuchtung

Questi apparecchi sono progettati per creare ambienti piacevoli e funzionali, ideali come luce di lettura diretta alla testa del letto.

Diese Leuchten wurden entwickelt, um angenehme und funktionelle Umgebungen zu schaffen, ideal als direktes Leselicht am Kopfende des Bettes.

**12V DC**

6W	5211020
15W	5211120
30W	5147420
50W	5147520
72W	5008520
100W	5209320
200W	5209420



Grazie ai bracci flessibili, è possibile regolare e orientare la luce in base alle proprie esigenze.

Dank der flexiblen Arme können Sie das Licht nach Ihren Bedürfnissen einstellen und ausrichten.

## Apparechio LED Quasar direzionale di lettura (12V DC) Richtstrahler Quasar LED zum Lesen (12 V DC)



Lumen	Potenza/Leistung	Temperatura di colore/ Farbtemperatur	Input	Finitura/Fertigstellung	Imballaggio/Verpackung	Cod.
166 lm	3 W	Bianco naturale 4.000 K/ Naturweiß 4.000 K	12V DC	Plastica bianca/Weißer Kunststoff	1 UN/Einh	5218315

Tecnoplastica/Kunststoff

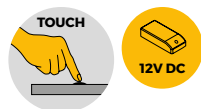

0,25 m		555 lx	995 lx
0,50 m		149 lx	268 lx
0,75 m		70 lx	124 lx
1,00 m		41 lx	68 lx
1,25 m		28 lx	47 lx

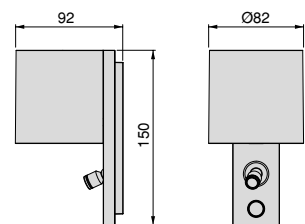

Luminaria LED Alioth flexible con puerto de carga USB-A de 5V DC-1A Max. (12V DC)  
Luminária LED Alioth flexível com porta de carregamento USB-A 5V DC-1A Max. (12V DC)



Lumen	Potenza/Leistung	Temperatura di colore/ Farbtemperatur	Input	Output	Finitura/Fertigstellung	Imballaggio/ Verpackung	Cod.
68 lm	1,2 W	Bianco naturale 4.000 K/ Naturweiß 4.000 K	12V DC Min 15W	5V DC 1A Max.	Verniciato nero/ Schwarz	1 UN/Einh	5218114

Tecnoplastica/Kunststoff

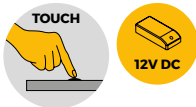

Luminaria LED Algot flexible con puerto de carga USB-A de 5V DC-1A Max. (12V DC)  
Flexible Algot LED-Leuchte mit USB-A 5V DC-1A Max. Ladeanschluss (12V DC)



Lumen	Potenza/Leistung	Temperatura di colore/ Farbtemperatur	Input	Output	Finitura/Fertigstellung	Imballaggio/ Verpackung	Cod.
93 lm	1,8 W	Bianco naturale 4.000 K/ Naturweiß 4.000 K	12V DC Min 15W	5V DC 1A Max.	Verniciato nero/ Schwarz	1 UN/Einh	5218214

Tecnoplastica/Kunststoff

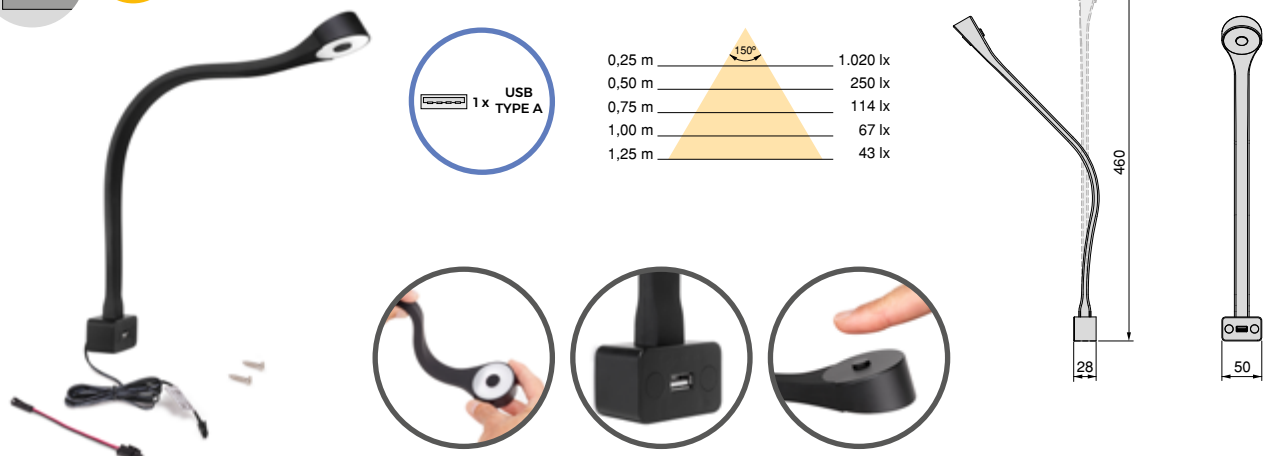
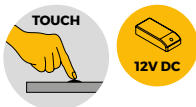

# Lampade Beleuchtung

Sono il modo classico per illuminare i vostri mobili in modo pratico e funzionale, con la migliore tecnologia LED.

Sie sind die klassische Art, Ihre Möbel auf praktische und funktionelle Weise zu beleuchten, mit der besten LED-Technologie.

**AC 230V  
50Hz**

**12V DC**

6W	5211020
15W	5211120
30W	5147420
50W	5147520
72W	5008520
100W	5209320
200W	5209420



## Faretto LED CruX

### LED Wandleuchte CruX (12V DC)

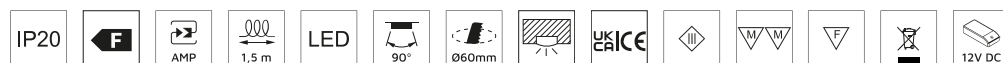

Lumen	Potenza/Leistung	Temperatura di colore/ Farbtemperatur	LEDs	Finitura/Fertigstellung	Imballaggio/Verpackung	Cod.
105 lm	1,8 W	Bianco freddo 6.000 K/ Kaltweiß 6.000 K	24	Verniciato alluminio/ Grau metallic	6 UN/Einh	5914525
105 lm	1,8 W	Bianco freddo 6.000 K/ Kaltweiß 6.000 K	24	Nichel satinado/Nickel satinert	6 UN/Einh	5914551
110 lm	1,8 W	Bianco naturale 4.500 K/ Naturweiß 4.500 K	24	Nichel satinado/Nickel satinert	6 UN/Einh	5914651

Tecnoplastica/Kunststoff

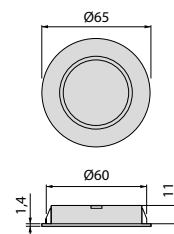
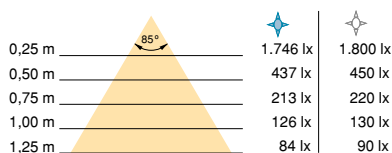

**Faretto LED Crux-in per l'incasso nei mobili senza la necessità di un convertitore (AC 230V 50Hz)**  
**Crux-in LED Einbauleuchte zum einbetten in Möbel ohne Spannungswandler benötigt (AC 230V 50Hz)**

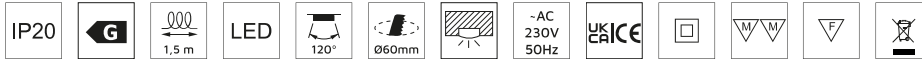

Lumen	Potenza/Leistung	Temperatura di colore/ Farbtemperatur	LEDs	Finitura/Fertigstellung	Imballaggio/Verpackung	Cod.
116 lm	1,8 W	Bianco freddo 6.000 K/ Kaltweiß 6.000 K	24	Verniciato alluminio/ Grau metallic	6 UN/Einh	5915225
116 lm	1,8 W	Bianco freddo 6.000 K/ Kaltweiß 6.000 K	24	Nichel satinado/Nickel satinert	6 UN/Einh	5915251
116 lm	1,8 W	Bianco naturale 4.000 K/ Naturweiß 4.000 K	24	Nichel satinado/Nickel satinert	6 UN/Einh	5915351

Tecnoplastica/Kunststoff

AC 230V  
50Hz

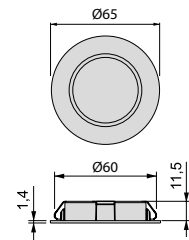
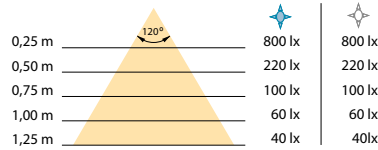

**Faretto LED Crux-in-Q**  
**LED Wandleuchte Crux-in-Q (AC 230V 50Hz)**



Lumen	Potenza/Leistung	Temperatura di colore/ Farbtemperatur	LEDs	Finitura/Fertigstellung	Imballaggio/Verpackung	Cod.
101 lm	1,8 W	Bianco naturale 4.000 K/ Naturweiß 4.000 K	24	Verniciato nero/ Schwarz	6 UN/Einh	5203914
101 lm	1,8 W	Bianco naturale 4.000 K/ Naturweiß 4.000 K	24	Nichel satinado/Nickel satinert	6 UN/Einh	5203951

Tecnoplastica/Kunststoff

AC 230V  
50Hz

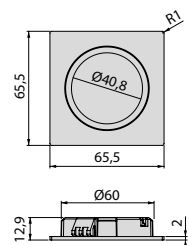
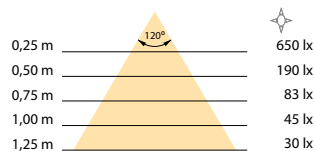

Faretto LED Mizar per l'incasso nei mobili senza la necessità di un convertitore.  
Mizar Einbauleuchte für Möbel ohne Netzteil (AC 230V 50Hz)



A	Diametro/Durchmesser	Lumen	Potenza/Leistung	Temperatura di colore/Farbtemperatur	LEDs	Finitura/Fertigstellung	Imballaggio/Verpackung	Cod.
66	66	200 lm	3 W	Bianco naturale 4.000 K/ Naturweiß 4.000 K	24	Nichel satinado/ Nickel satiniert	6 UN/Einh	5040151

Acciaio, Tecnoplastica/Kunststoff, Stahl

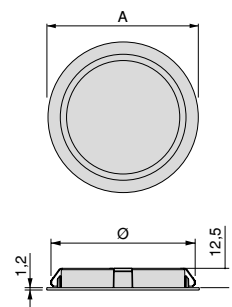
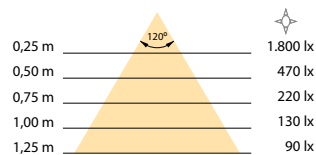

Faretto LED Polaris  
LED Wandleuchte Polaris (12V DC)



Lumen	Potenza/Leistung	Temperatura di colore/Farbtemperatur	LEDs	Finitura/Fertigstellung	Imballaggio/Verpackung	Cod.
95 lm	1,2 W	Bianco naturale 4.000 K/ Naturweiß 4.000 K	1	Anodizzato opaco/ Matt eloxiert	6 UN/Einh	502262

Alluminio/Aluminium

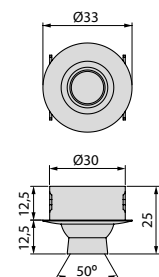

**Faretto LED Spot**  
**LED Wandleuchte Spot (12V DC)**

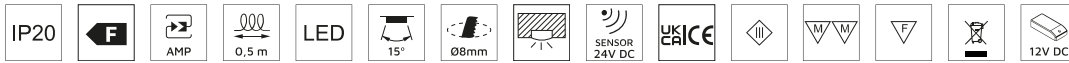

Lumen	Potenza/Leistung	Temperatura di colore/ Farbtemperatur	LEDs	Finitura/Fertigstellung	Imballaggio/Verpackung	Cod.
8 lm	0,3 W	Bianco freddo 6.000 K/ Kaltweiß 6.000 K	1	Cromato lucido/ Verchromt	10 UN/Einh	7015611

Tecnoplastica/Kunststoff

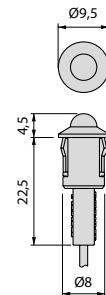
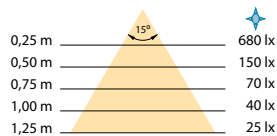

**Faretto LED Alcor**  
**LED Wandleuchte Alcor (12V DC)**



Lumen	Potenza/Leistung	Temperatura di colore/ Farbtemperatur	LEDs	Finitura/Fertigstellung	Imballaggio/Verpackung	Cod.
95 lm	1,2 W	Bianco naturale 4.000 K/ Naturweiß 4.000 K	1	Anodizzato opaco/ Matt eloxiert	6 UN/Einh	5022362

Alluminio/Aluminium

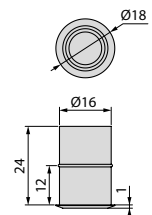

# Installazione di base Grundausrüstung

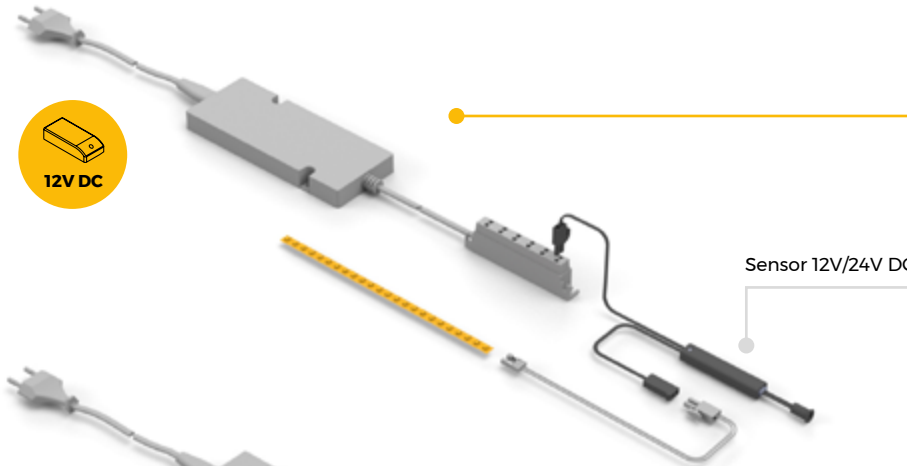

Installazione **12V DC**  
Einrichtung **12V DC**

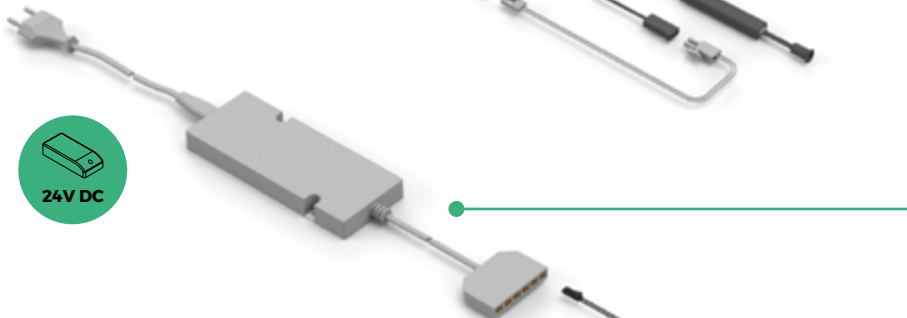

Installazione **24V DC**  
Einrichtung **24V DC**

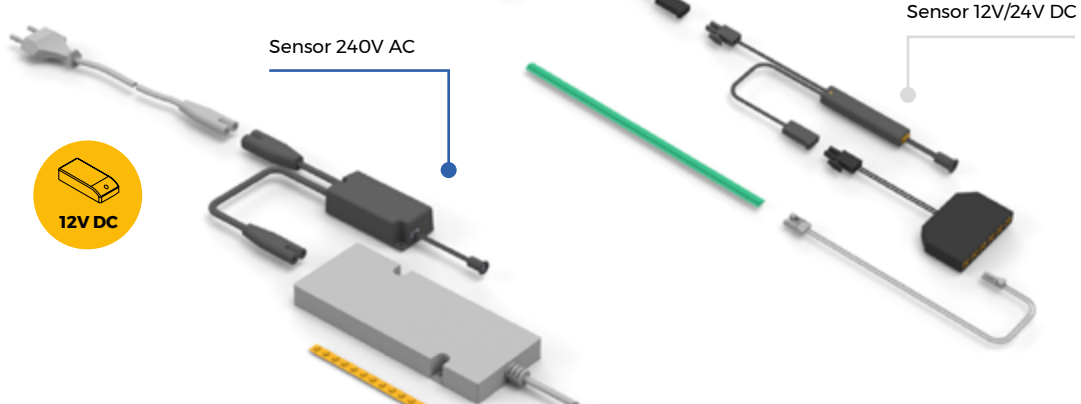

Installazione **24V AC - 12V DC**  
Einrichtung **24V AC - 12V DC**

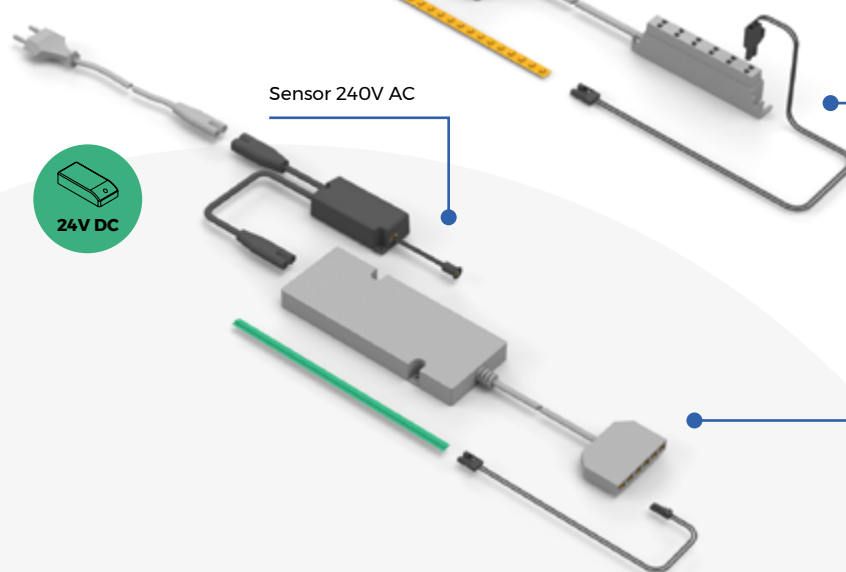

Installazione **24V AC - 24V DC**  
Einrichtung **24V AC - 24V DC**



6W	5211020
15W	5211120
30W	5147420
50W	5147520
72W	5008520
100W	5209320
200W	5209420



15W	5211220
30W	5147620
50W	5147720
100W	5209520

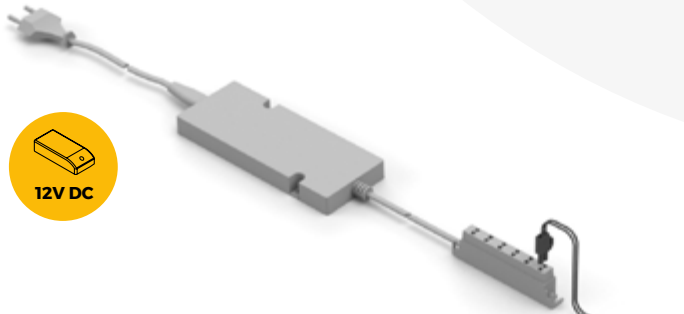

**Installazione Lynx 12V DC  
Einrichtung Lynx 12V DC**

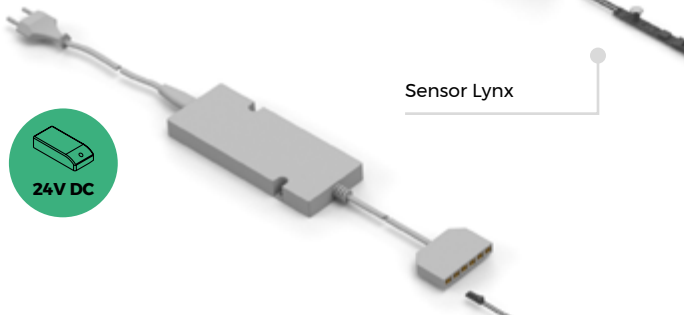

**Installazione Lynx 24V DC  
Einrichtung Lynx 24V DC**

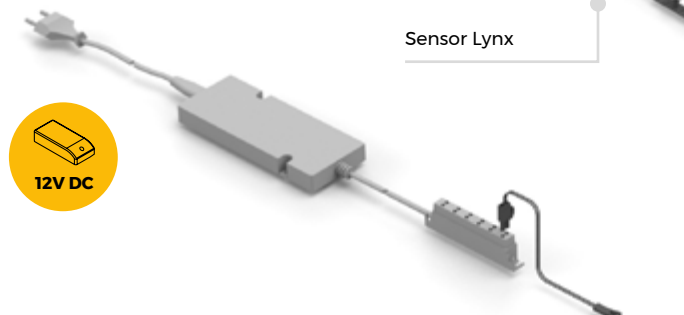

**Installazione Wirly 12V DC  
Einrichtung Wirly 12V DC**

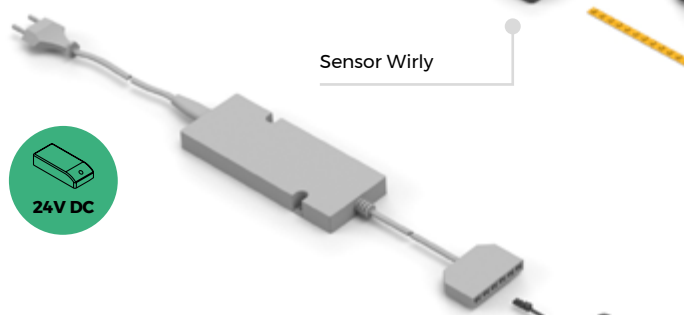

**Installazione Wirly 24V DC  
Einrichtung Wirly 24V DC**



Convertitore per illuminazioni LED di tensione costante, tecnoplastica (12V DC)  
 Konstantspannungswandler für LED-Leuchtkörper, kunststoff (12V DC)

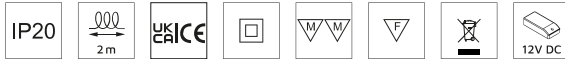

A	B	C	Potenza/ Leistung	Input	Output	Finitura/Fertigstellung	Imballaggio/ Verpackung	Cod.
16,2	96	41	6 W	180-240V AC - 50Hz	12V DC	Non classificata/ Nicht bestimmt	<input type="checkbox"/>	5211020
16,2	96	41	15 W	180-240V AC - 50Hz	12V DC	Non classificata/ Nicht bestimmt	<input type="checkbox"/>	5211120
17	164	65	30 W	100-240V AC - 50-60Hz	12V DC	Non classificata/ Nicht bestimmt	<input type="checkbox"/>	5147420
17	164	65	50 W	100-240V AC - 50-60Hz	12V DC	Non classificata/ Nicht bestimmt	<input type="checkbox"/>	5147520
38	153	60	72 W	100-240V AC - 50-60Hz	12V DC	Non classificata/ Nicht bestimmt	<input type="checkbox"/>	5008520

Tecnoplastica/Kunststoff

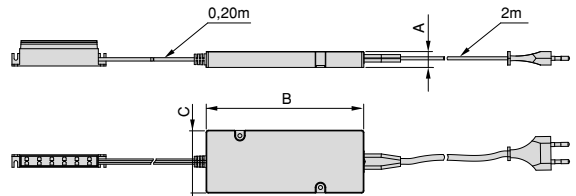
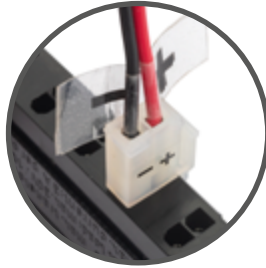

Convertitore per illuminazioni LED di tensione costante (12V DC)  
 Konstantspannungswandler für LED-Leuchtkörper (12V DC)



A	B	C	Potenza/ Leistung	Input	Output	Finitura/Fertigstellung	Imballaggio/ Verpackung	Cod.
18	160	58	100 W	200-240V AC - 50-60Hz	12V DC	Non classificata/ Nicht bestimmt	<input type="checkbox"/>	5209320
35	205	71	200 W	200-240V AC - 50-60Hz	12V DC	Non classificata/ Nicht bestimmt	<input type="checkbox"/>	5209420

Acciaio, Alluminio/Aluminium, Stahl

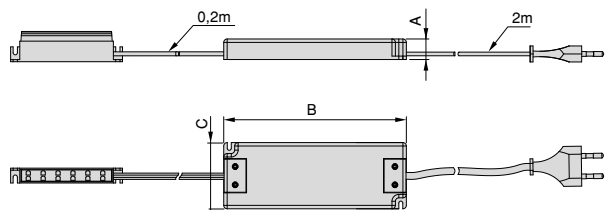

**Convertitore per illuminazioni LED di tensione costante, tecnoplastica (24V DVC)**  
**Konstantspannungswandler für LED-Leuchtkörper, kunststoff (24V DVC)**

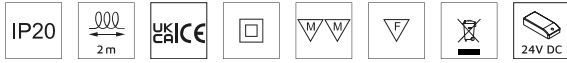

A	B	C	Potenza/ Leistung	Input	Output	Finitura/Fertigstellung	Imballaggio/ Verpackung	Cod.
16,2	96	41	15 W	180-240V AC - 50Hz	24V DC	Non classificata/ Nicht bestimmt	10 UN/Einh	5211220
17	164	65	30 W	100-240V AC - 50-60Hz	24V DC	Non classificata/ Nicht bestimmt	10 UN/Einh	5147620
17	164	65	50 W	100-240V AC - 50-60Hz	24V DC	Non classificata/ Nicht bestimmt	10 UN/Einh	5147720

Acciaio, Alluminio/  
Aluminium, Stahl

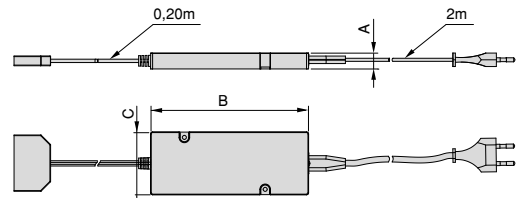
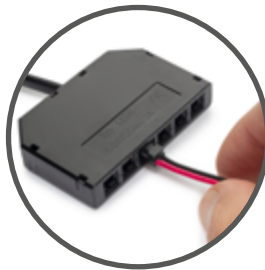

**Convertitore per illuminazioni LED di tensione costante (24V DC)**  
**Konstantspannungswandler für LED-Leuchtkörper (24V DC)**



A	B	C	Potenza/ Leistung	Input	Output	Finitura/Fertigstellung	Imballaggio/ Verpackung	Cod.
18	160	58	100 W	200-240V AC - 50-60Hz	24V DC	Non classificata/ Nicht bestimmt	5 UN/Einh	5209520

Acciaio, Alluminio/Aluminium, Stahl

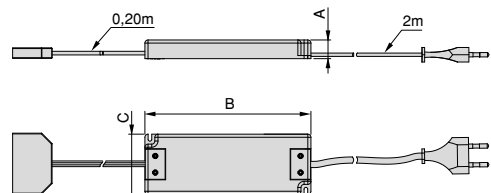

**Sensori LED Point switch SIMPLE (interruttore) 240V AC**  
**LED Sensor Point switch SIMPLE (Schalter) 240V AC**

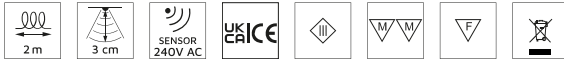

Modello/Modell	Potenza/Leistung	Input	Output	Finitura/Fertigstellung	Imballaggio/Verpackung	Cod.
SWITCH SIMPLE	Max. 250 W	100-240V AC 50-60Hz	100-240V AC 50-60Hz	Verniciato alluminio/ Grau metallic	10 UN/Einh	5040525

Tecnoplastica/Kunststoff

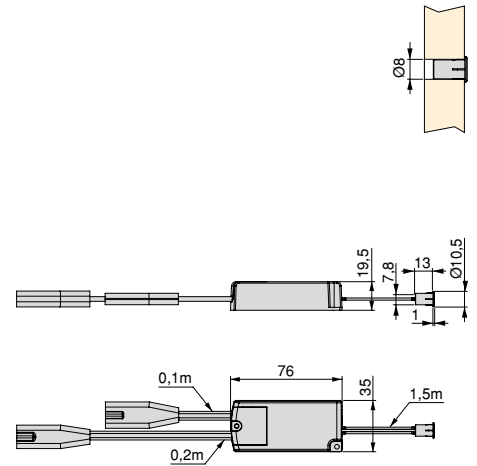
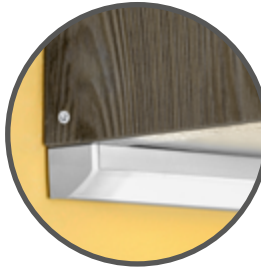
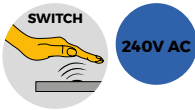

**Sensori LED Point switch DOUBLE (interruttore) 240V AC**  
**LED Sensor Point switch DOPPELTER (Schalter) 240V AC**



Modello/Modell	Potenza/Leistung	Input	Output	Finitura/Fertigstellung	Imballaggio/Verpackung	Cod.
SWITCH DOBLE	Max. 250 W	100-240V AC 50-60Hz	100-240V AC 50-60Hz	Verniciato alluminio/ Grau metallic	10 UN/Einh	5040625

Tecnoplastica/Kunststoff

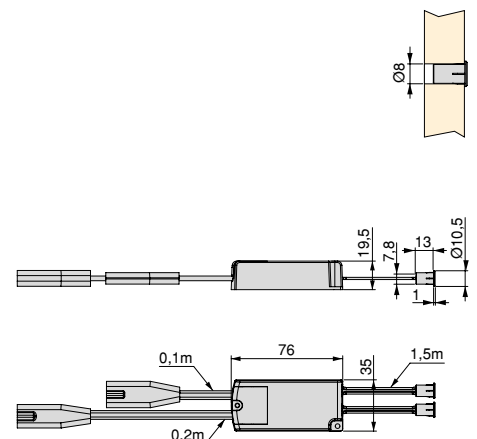
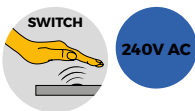

**Sensori LED Point door SIMPLE (prossimità) 240V AC**  
**LED Sensor Point door SIMPLE (Annäherungssensor) 240V AC**

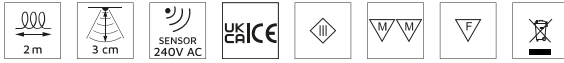

Modello/Modell	Potenza/Leistung	Input	Output	Finitura/Fertigstellung	Imballaggio/Verpackung	Cod.
DOOR SIMPLE	Max. 250 W	100-240V AC 50-60Hz	100-240V AC 50-60Hz	Verniciato alluminio/ Grau metallic	10 UN/Einh	5040725

Tecnoplastica/Kunststoff

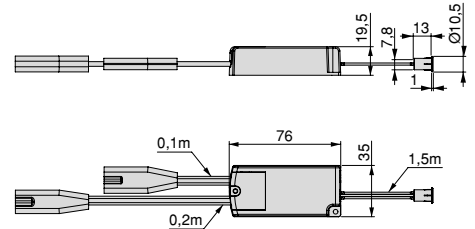
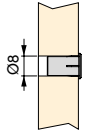
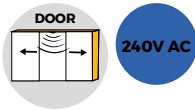

**Sensori LED Point door DOUBLE (prossimità) 240V AC**  
**LED Sensor Point door DOPPELTER (Annäherungssensor) 240V AC**

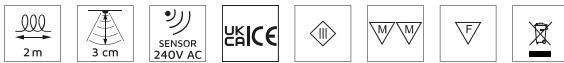

Modello/Modell	Potenza/Leistung	Input	Output	Finitura/Fertigstellung	Imballaggio/Verpackung	Cod.
DOOR DOBLE	Max. 250 W	100-240V AC 50-60Hz	100-240V AC 50-60Hz	Verniciato alluminio/ Grau metallic	10 UN/Einh	5040825

Tecnoplastica/Kunststoff

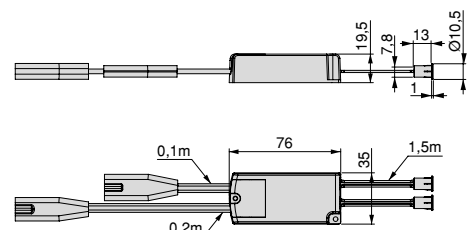
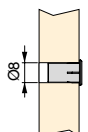
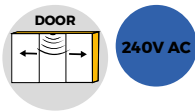

**Sensori LED Red Eye 4 motion (movimento) 240V AC**  
**LED Sensor Red Eye 4 motion (Bewegung) 240V AC**



Modello/Modelo	Potenza/Leistung	Input	Output	Finitura/Fertigstellung	Imballaggio/Verpackung	Cod.
MOTION SIMPLE	250 W	100-240V AC 50-60Hz	100-240V AC 50-60Hz	Non classificata/Nicht bestimmt	<input type="checkbox"/> 10 UN/Einh	7001820

Tecnoplastica/Kunststoff

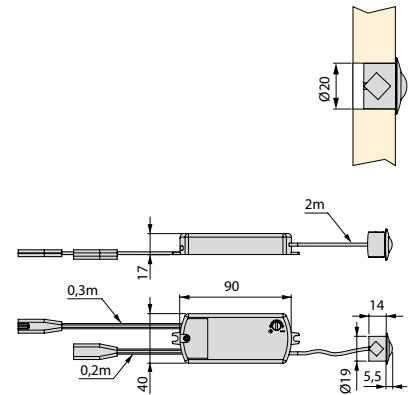
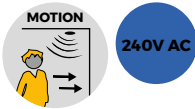

**Sensori LED Red Eye 5 metal (tattile) 240V AC**  
**LED Sensor Red Eye 5 metal (Berührung) 240V AC**



Modello/Modell	Potenza/Leistung	Input	Output	Finitura/Fertigstellung	Imballaggio/Verpackung	Cod.
METAL SIMPLE	500 W	220-240V AC - 50Hz	220-240V AC 50-60Hz	Non classificata/Nicht bestimmt	<input type="checkbox"/> 10 UN/Einh	7001920

Tecnoplastica/Kunststoff

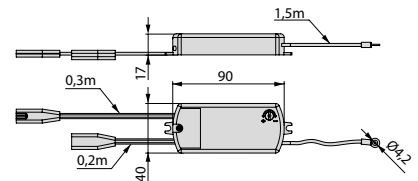
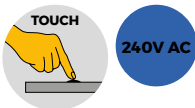

**Bussola estetica e vite**  
**Ziermutter und Schraube**

Finitura/Fertigstellung	Imballaggio/Verpackung	Cod.
Cromato lucido/Verchromt	<input type="checkbox"/> 10 UN/Einh	7006011

Acciaio/Stahl

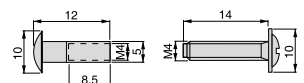

**Sensori LED Point switch SIMPLE (interruttore) 12V DC / 24V DC**  
**LED Sensor Point switch SIMPLE (Schalter) 12V DC / 24V DC**



Modello/Modell	Potenza/Leistung	Input	Output	Finitura/Fertigstellung	Imballaggio/Verpackung	Cod.
SWITCH SIMPLE	36 W (12V DC) - 72 W (24V DC)	12V DC - 24V DC	12V DC - 24V DC	Verniciato alluminio/ Grau metallic	6 UN/Einh	5022925

Tecnoplastica/Kunststoff

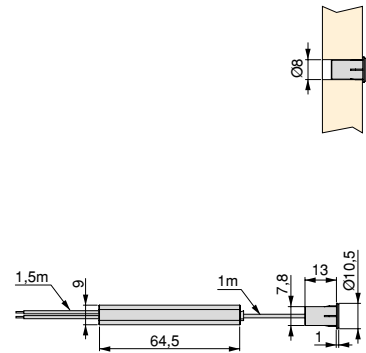
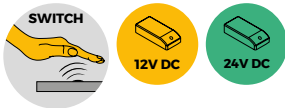

**Sensori LED Point switch DOUBLE (interruttore) 12V DC / 24V DC**  
**LED Sensor Point switch DOPPELTER (Schalter) 12V DC / 24V DC**



Modello/Modell	Potenza/Leistung	Input	Output	Finitura/Fertigstellung	Imballaggio/Verpackung	Cod.
SWITCH DOBLE	36 W (12V DC) - 72 W (24V DC)	12V DC - 24V DC	12V DC - 24V DC	Verniciato alluminio/ Grau metallic	6 UN/Einh	5023025

Tecnoplastica/Kunststoff

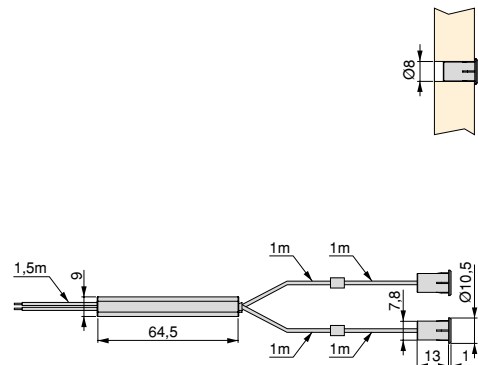
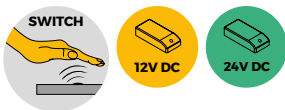

**Sensori LED Point door (prossimità) 12V DC / 24V DC**  
**LED Sensor Point door (Annäherungssensor) 12V DC / 24V DC**



Modello/Modell	Potenza/Leistung	Input	Output	Finitura/Fertigstellung	Imballaggio/Verpackung	Cod.
DOOR SIMPLE	36 W (12V DC) - 72 W (24V DC)	12V DC - 24V DC	12V DC - 24V DC	Verniciato alluminio/ Grau metallic	6 UN/Einh	5023225

Tecnoplastica/Kunststoff

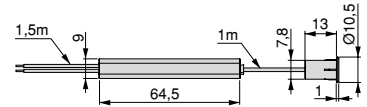
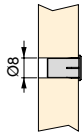
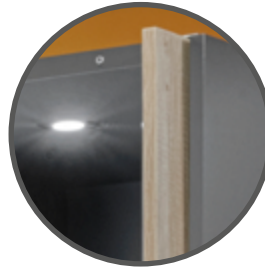
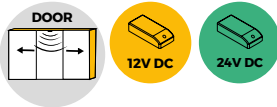

**Sensori LED Point motion (movimento) 12V DC / 24V DC**  
**LED Sensor Point motion (Bewegung) 12V DC / 24V DC**



Modello/Modell	Potenza/Leistung	Input	Output	Finitura/Fertigstellung	Imballaggio/Verpackung	Cod.
MOTION SIMPLE	36 W (12V DC) - 72 W (24V DC)	12V DC - 24V DC	12V DC - 24V DC	Non classificata/Nicht bestimmt	6 UN/Einh	5023120

Tecnoplastica/Kunststoff

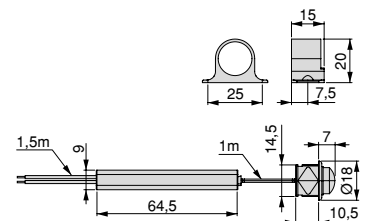
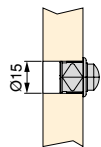
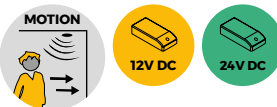

**Sensori LED Dot Ø16 switch/dimmer (interruttore) 12V DC / 24V DC**  
**LED Sensor Dot Ø16 switch/dimmer (Schalter) 12V DC / 24V DC**

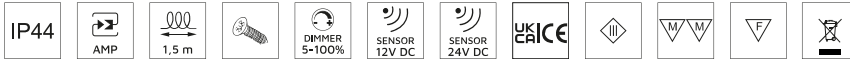

Modello/Modell	Potenza/Leistung	Input	Output	Finitura/Fertigstellung	Imballaggio/Verpackung	Cod.
SWITCH DIMMER SIMPLE	36 W (12V DC) - 72 W (24V DC)	12V DC - 24V DC	12V DC - 24V DC	Verniciato alluminio/ Grau metallic	6 UN/Einh	5022825

Tecnoplastica/Kunststoff

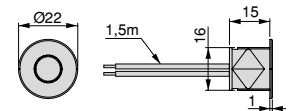
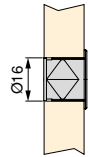
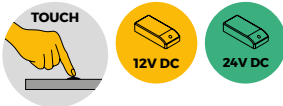

**Sensori LED Dot Ø12 switch/dimmer (interruttore) 12V DC / 24V DC**  
**LED Sensor Dot Ø12 switch/dimmer (Schalter) 12V DC / 24V DC**



Modello/Modell	Potenza/Leistung	Input	Output	Finitura/Fertigstellung	Imballaggio/Verpackung	Cod.
SWITCH DIMMER SIMPLE	36 W (12V DC) - 72 W (24V DC)	12V DC - 24V DC	12V DC - 24V DC	Verniciato alluminio/ Grau metallic	6 UN/Einh	5218425

Tecnoplastica/Kunststoff

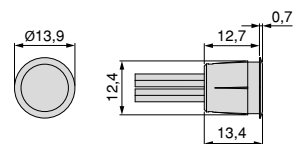
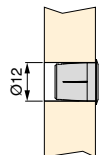
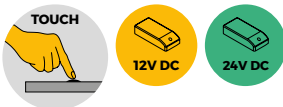



**Sensori LED Micron switch/dimmer (interruttore) 12V DC / 24V DC**  
**LED Sensor Micron switch/dimmer (Schalter) 12V DC / 24V DC**



Modello/Modell	Potenza/Leistung	Input	Output	Finitura/Fertigstellung	Imballaggio/Verpackung	Cod.
SWITCH DIMMER SIMPLE	24 W (12V DC) - 48 W (24V DC)	12V DC - 24V DC	12V DC - 24V DC	Verniciato alluminio/ Grau metallic	6 UN/Einh	5053125

Tecnoplastica/Kunststoff

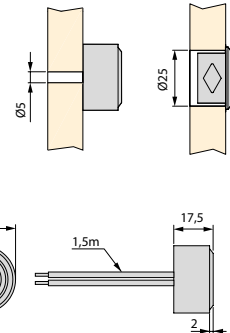
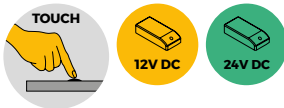

**Sensori LED Spirit switch/dimmer (interruttore) sensore nascosto 12V DC**  
**LED Sensor Spirit switch/dimmer (Schalter) versteckter Sensor 12V DC**



Modello/Modell	Potenza/Leistung	Input	Output	Finitura/Fertigstellung	Imballaggio/Verpackung	Cod.
SWITCH DIMMER SIMPLE	Max. 80 W	12V DC	12V DC	Plastica nera/Schwarzer Kunststoff	6 UN/Einh	5022617

Tecnoplastica/Kunststoff

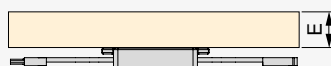
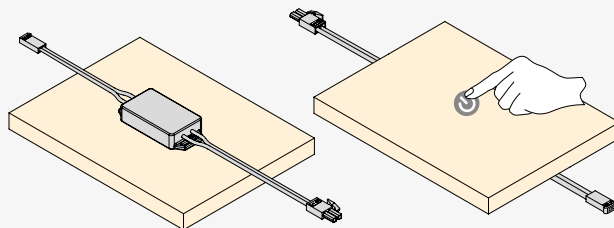
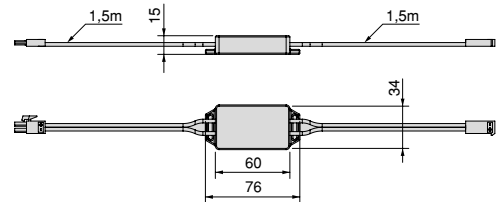
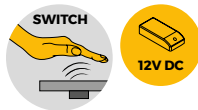

Sensore nascosto che attraversa diversi materiali con spessore fino a 32 mm.  
 Non compatibile con specchio specchi e metalli.

- E < 32 mm Legno.
- E < 22 mm Tecnoplastica.
- E < 20 mm Pietra.
- E < 12 mm Vetro.

Versteckter Sensor, der Materialien mit einer Dicke von bis zu 32 mm durchdringt.  
 Nicht kompatibel mit Spiegeln und Metallen.

- E < 32 mm Holz.
- E < 22 mm Kunststoff.
- E < 20 mm Stein.
- E < 12 mm Glas.

**Telecomando ultrasottile RGB per illuminazione**  
**Fernbedienung RGB für Beleuchtung**



Finitura/Fertigstellung	Imballaggio/Verpackung	Cod.
Non classificata/Nicht bestimmt <input type="checkbox"/>	1 UN/Einh	5205520

Tecnoplastica/Kunststoff

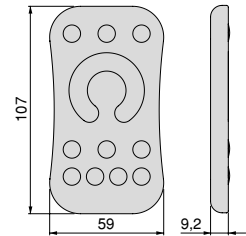

**Telecomando ultrasottile Dimmer per illuminazione**  
**Fernbedienung Dimmer für Beleuchtung**



Finitura/Fertigstellung	Imballaggio/Verpackung	Cod.
Non classificata/Nicht bestimmt <input type="checkbox"/>	1 UN/Einh	5205720

Tecnoplastica/Kunststoff

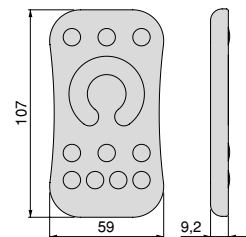

**Controllo LED Per illuminazione**  
**LED Controller**



Finitura/Fertigstellung	Imballaggio/Verpackung	Cod.
Non classificata/Nicht bestimmt <input type="checkbox"/>	1 UN/Einh	5205920

Tecnoplastica/Kunststoff

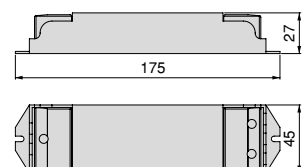

**Ricevitore per sensori LED Wirly 12V DC / 24V DC**  
**Sensor-Empfänger LED Wirly 12V DC / 24V DC**

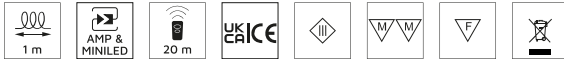

Potenza/Leistung	Input	Output	Finitura/Fertigstellung	Imballaggio/Verpackung	Cod.
36 W (12V DC) - 72 W (24V DC)	12V DC - 24V DC	12V DC - 24V DC	Non classificata/Nicht bestimmt	10 UN/Einh	5215020

Tecnoplastica/Kunststoff

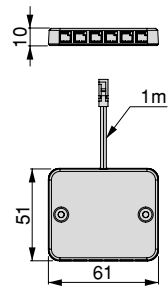
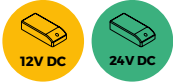

Un trasmettitore può essere collegato a un massimo di 8 ricevitori e un ricevitore può essere collegato a un massimo di 10 trasmettitori diversi.

Ein Sender kann mit bis zu 8 Empfängern verbunden werden und ein Empfänger kann mit bis zu 10 verschiedenen Sendern verbunden werden.

Il sistema di rilevamento Wirly è composto da un ricevitore e da un trasmettitore di segnale che consente di accendere e spegnere gli apparecchi da qualsiasi punto tramite radiofrequenza.

Das Wirly-Detektionssystem besteht aus einem Empfänger und einem Signalsender, der das Ein- und Ausschalten der Leuchten von jedem beliebigen Punkt aus per Funk ermöglicht.

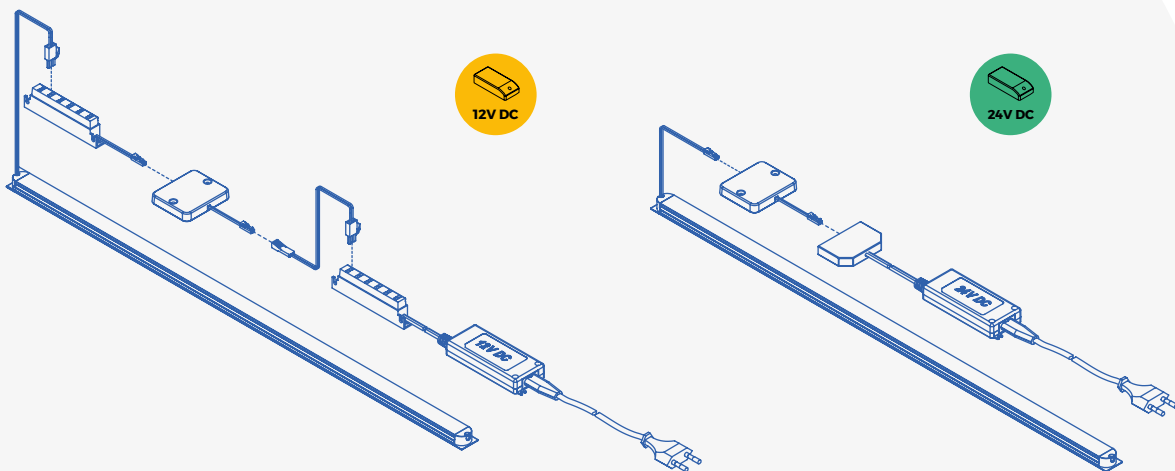

**Trasmettitore per sensori LED Wirly switch/dimmer (interruttore) 12V DC / 24V DC**  
**Sender für Näherung LED Wirly switch/dimmer (Schalter) 12V DC / 24V DC**



Modello/Modell	Finitura/Fertigstellung	Imballaggio/Verpackung	Cod.
SWITCH DIMMER SIMPLE	Non classificata/Nicht bestimmt <input type="checkbox"/>	10 UN/Einh	5215120

Tecnoplastica/Kunststoff

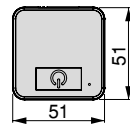
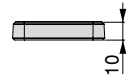

**Trasmettitore per sensori LED Wirly switch/motion (movimento) 12V DC / 24V DC**  
**Sender für Näherung LED Wirly switch/motion (Bewegung) 12V DC / 24V DC**



Modello/Modell	Finitura/Fertigstellung	Imballaggio/Verpackung	Cod.
MOTION SIMPLE	Non classificata/Nicht bestimmt <input type="checkbox"/>	10 UN/Einh	5215220

Tecnoplastica/Kunststoff

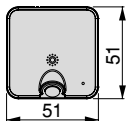
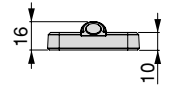

**Trasmettitore per sensori LED Wirly door (prossimità) 12V DC / 24V DC**  
**Sender für Näherung LED Wirly door (Näherung) 12V DC / 24V DC**



Modello/Modell	Finitura/Fertigstellung	Imballaggio/Verpackung	Cod.
DOOR SIMPLE / DOOR DOBLE / PROXIMITY DIMMER	Non classificata/Nicht bestimmt <input type="checkbox"/>	10 UN/Einh	5215320

Tecnoplastica/Kunststoff

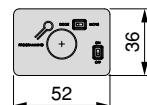
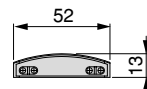
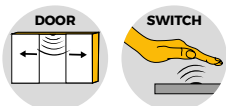

**Prolunga AMP (12V DC)**  
**Verlängerungskabel AMP (12V DC)**



Lunghezza/Längengrad	Potenza/Leistung	Finitura/Fertigstellung	Imballaggio/Verpackung	Cod.
2 m	Max. 60 W	Plastica nera/Schwarzer Kunststoff	25 UN/Einh	9269817

Tecnoplastica/Kunststoff

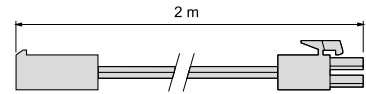

**Contattiera AMP 12V**  
**12V AMP Verteilerkabel**

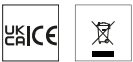

Lunghezza/Längengrad	Finitura/Fertigstellung	Imballaggio/Verpackung	Cod.
0.25 m	Plastica bianca/Weißer Kunststoff	10 UN/Einh	7065715

Tecnoplastica/Kunststoff

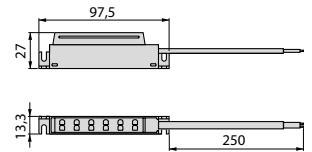

**Kit adattatore AMP per Miniled per sensori (12V DC) (24V DC)**  
**Satz AMP zu MiniLED Adapter für Sensoren (12V DC) (24V DC)**



Finitura/Fertigstellung	Imballaggio/Verpackung	Cod.
Non classificata/Nicht bestimmt	10 UN/Einh	5205020

Tecnoplastica/Kunststoff

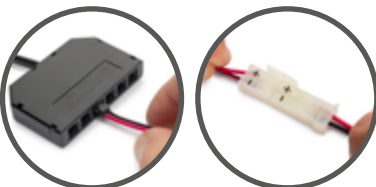
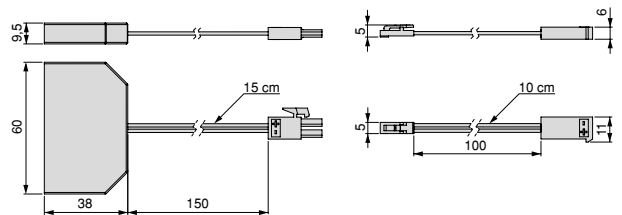

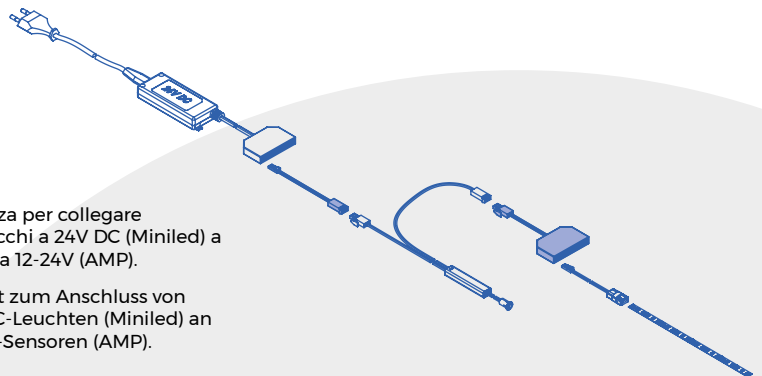

Si utilizza per collegare apparecchi a 24V DC (Miniled) a sensori a 12-24V (AMP).

Es dient zum Anschluss von 24-V-DC-Leuchten (Miniled) an 12-24-V-Sensoren (AMP).



**Interruttore per anta armadio**  
**Lichtschalter für Schranktür**



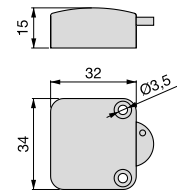
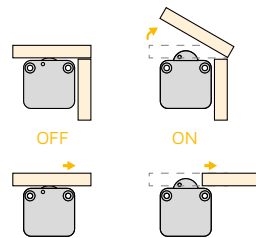

Finitura/Fertigstellung	Imballaggio/Verpackung	Cod.
Plastica bianca/Weißer Kunststoff 	10 UN/Einh	9642415
Plastica nera/Schwarzer Kunststoff 	10 UN/Einh	9642417

Tecnoplastica/Kunststoff



**Interruttore da incasso D21x21**  
**Schalter zum Einbauen D21x21**



Finitura/Fertigstellung	Imballaggio/Verpackung	Cod.
Plastica bianca/Weißer Kunststoff 	10 UN/Einh	9640215
Plastica nera/Schwarzer Kunststoff 	10 UN/Einh	9640217
Plastica grigia/Grau 	10 UN/Einh	9640221

Tecnoplastica/Kunststoff

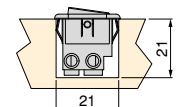
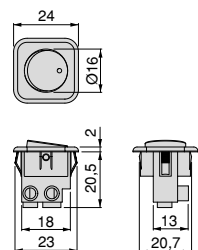

## Cariaca batterie Induktionsbatterie

I caricatori wireless sono progettati per ricaricare il tablet o lo smartphone in modo discreto e accessibile grazie alla loro completa integrazione nei mobili di casa e ufficio.

Die kabellosen Ladegeräte wurden entwickelt, um Ihr Tablet oder Smartphone auf diskrete und zugängliche Weise aufzuladen, dank ihrer vollständigen Integration in Wohn- und Büromöbel.



Consentono la ricarica wireless utilizzando la tecnologia wireless Qi (V1.1) solo su dispositivi compatibili con questo protocollo.

Sie ermöglichen das kabellose Laden mit der Qi-Funktechnologie (V1.1) nur für Geräte, die mit diesem Protokoll kompatibel sind.



Questo modello consente anche la ricarica di dispositivi elettronici tramite connessione USB.

Dieses Modell ermöglicht auch das Aufladen von elektronischen Geräten über einen USB-Anschluss.



Caricatore wireless nascosto per cellulari Airtop (Ø60mm)

Airtop 2 Induktionsbatterie versteckter für Handys (Ø60mm)



Input	Output	Finitura/Fertigstellung	Imballaggio/Verpackung	Cod.
100-240V AC - 50/60Hz	5V DC 2A (Qi-10W)	Plastica nera/Schwarzer Kunststoff	1 UN/Einh	5049317

Tecnoplastica/Kunststoff

AC 230V  
50Hz

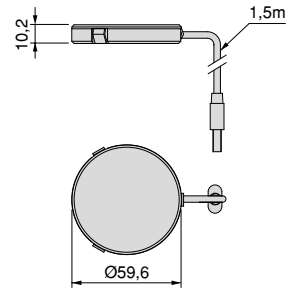
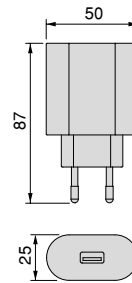
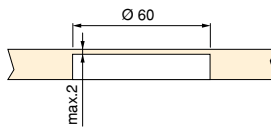

Caricatore mobile di superficie wireless USB-A Airtop 2 (Ø60 mm)

Airtop 2 USB-A Induktionsbatterie Von der Oberfläche für Handys (Ø60mm)



Input	Output	Finitura/Fertigstellung	Imballaggio/Verpackung	Cod.
100-240V AC - 50/60Hz	5V DC / 2.1A (USB-10W/ Qi-10W)	Plastica nera/Schwarzer Kunststoff	1 UN/Einh	5049217

Tecnoplastica/Kunststoff

AC 230V  
50Hz

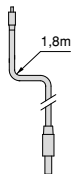
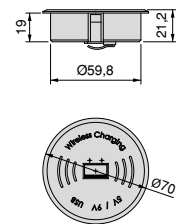
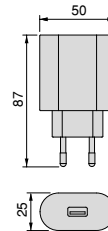
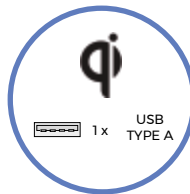
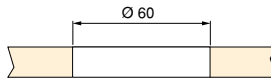



## Connettori Anschlüsse

I connettori multipli per la cucina, l'ufficio e la casa sono un accessorio essenziale, perché semplificano la vita e aggiungono funzionalità ai vostri mobili.

Die Multistecker für Küche, Büro und Haushalt sind ein unverzichtbares Accessoire, denn sie erleichtern das Leben und ergänzen die Funktionalität Ihrer Möbel.

Grazie alla loro totale integrazione nel mobile, i connettori sono completamente accessibili in ogni momento.

Dank ihrer vollständigen Integration in die Möbel sind die Anschlüsse jederzeit vollständig zugänglich.

Sono progettati per ricaricare dispositivi elettronici come tablet o telefoni cellulari in modo semplice e discreto.

Sie sind so konzipiert, dass sie elektronische Geräte wie Tablets oder Mobiltelefone einfach und diskret aufladen.

**Cargador Caricatore USB A+C Linky (81x12mm)**  
**Carregador Ladegerät USB A+C Linky (81x12mm)**

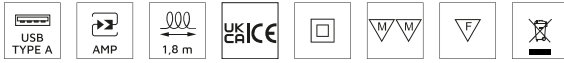

Input	Output	Finitura/Fertigstellung	Imballaggio/Verpackung	Cod.
100-240V AC - 50/60Hz	USB A - DC 5V-2A (10W) USB C - DC 5V-2A (10W)	Plastica nera/Schwarzer Kunststoff	1 UN/Einh	5049417

Tecnoplastica/Kunststoff

**AC 230V  
50Hz**

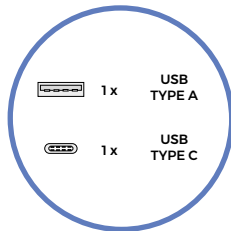
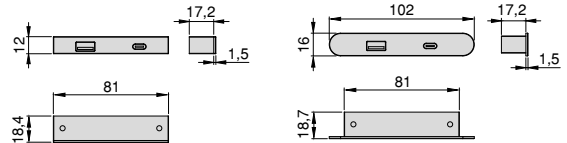

**Cargador Caricatore USB A+C Plugy tondo Ø37 (Ø25mm)**  
**Carregador Ladegerät USB A+C Plugy rund Ø37 (Ø25mm)**



Descrizioni/Beschreibung	Input	Output	Finitura/Fertigstellung	Imballaggio/Verpackung	Cod.
Ø37	12VDC-2.5A (30W) / 24VDC-1.5A (36W)	USB-A 18W: 5V-3A / 10V-2.22A / 12V-1.67A USB-C 20W: 5V-3A / 9V-2.22A / 12V-1.67A	Verniciato nero/ Schwarz	6 UN/Einh	5221114
Ø37	12VDC-2.5A (30W) / 24VDC-1.5A (36W)	USB-A 18W: 5V-3A / 10V-2.22A / 12V-1.67A USB-C 20W: 5V-3A / 9V-2.22A / 12V-1.67A	Verniciato alluminio/ Grau metallic	6 UN/Einh	5221125

Tecnoplastica/Kunststoff

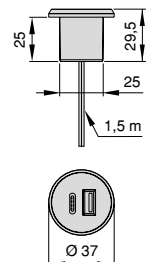
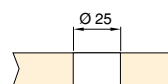
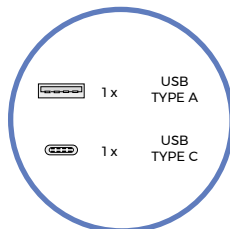

**Cargador/Caricatore USB Plugy tondo Ø37 (Ø25mm)**  
**Carregador Ladegerät USB Plugy rund Ø37 (Ø25mm)**

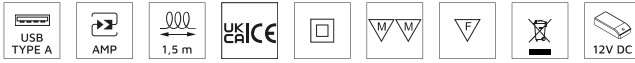

Descrizioni/Beschreibung	Input	Output	Finitura/Fertigstellung	Imballaggio/Verpackung	Cod.
Ø37	12V DC	5V DC	Verniciato nero/Schwarz	6 UN/Einh	5009014
Ø37	12V DC	5V DC	Verniciato alluminio/Grau metallic	6 UN/Einh	5009025

Tecnoplastica/Kunststoff

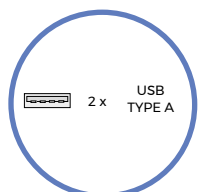
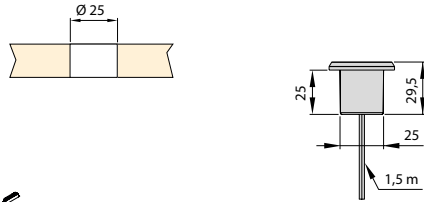
	Input	Output
	30 W 12V DC (2,50A)	5V DC - 3,40A MAX. (1 x 3,40A) (2 x 1,70A)
	15 W 12V DC (1,25A)	5V DC - 1,70A MAX. (1 x 1,70A) (2 x 0,85A)





**Cargador/Caricatore rotondo Plugy con 2 porte USB a incasso nel mobile (Ø25mm)**  
**Carregador Ladegerät USB rund Plugy mit 2 USB-Anschlüssen zur Einbettung in Möbel (Ø25mm)**

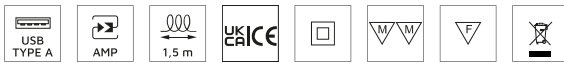

Descrizioni/Beschreibung	Finitura/Fertigstellung	Imballaggio/Verpackung	Cod.
Ø37	Verniciato nero/Schwarz	1 KIT/SET	5070614
Ø37	Verniciato alluminio/Grau metallic	1 KIT/SET	5070625

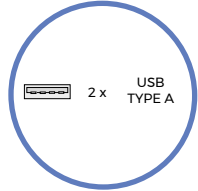
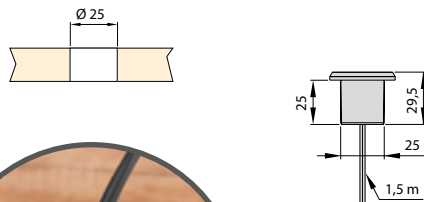
Tecnoplastica/Kunststoff







**Connettore One ad incastro nel mobile (Ø54mm)**  
**Einfacher Stecker zur Einbettung One in Möbel (Ø54mm)**

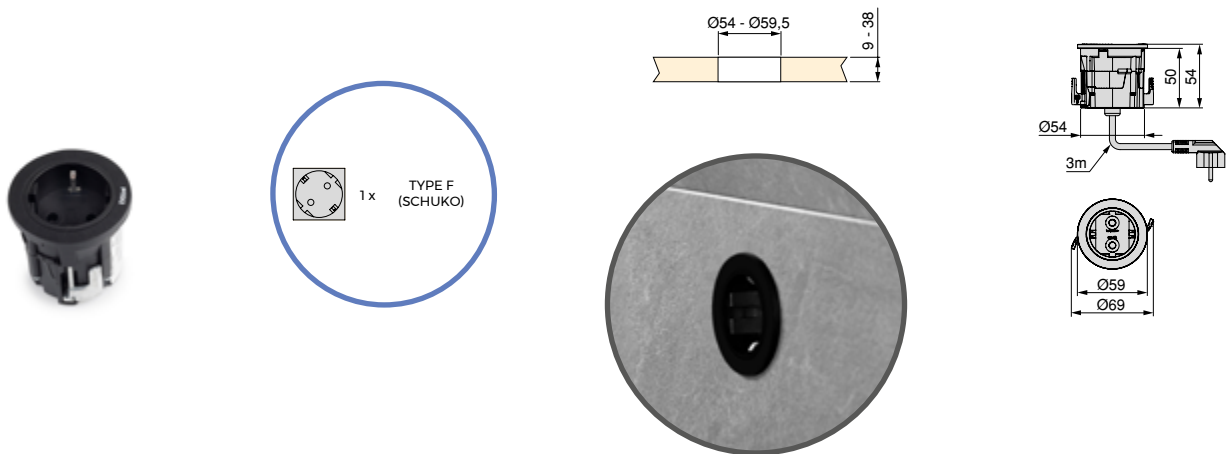

Finitura/Fertigstellung	Imballaggio/Verpackung	Cod.
Verniciato nero/Schwarz	1 UN/Einh	5048314

Tecnoplastica/Kunststoff



**Multiconnettore Vertikal Flat 60 con copertura scorrevole (Ø60mm)**  
**Mehrfach-Steckerleiste Vertikal Flat 60 mit Schiebedeckel (Ø60mm)**



Potenza/Leistung	Finitura/Fertigstellung	Imballaggio/Verpackung	Cod.
USB-A - DC 5V-2.4A (12W)	Acciaio inossidabile/Edelstahl	1 UN/Einh	5048065

Acciaio, Tecnoplastica/Kunststoff, Stahl

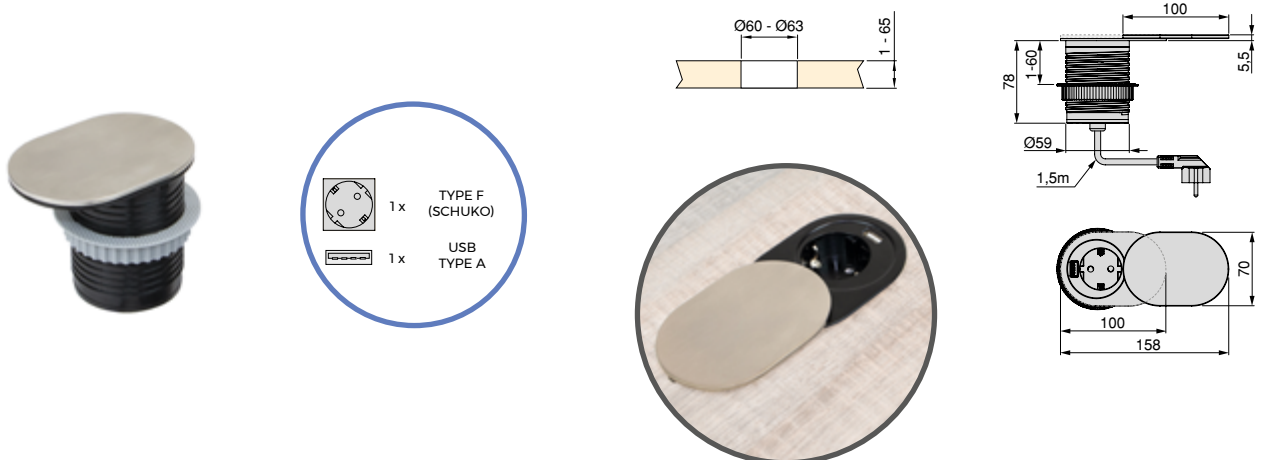

# Connettori Anschlüsse

Spina e presa per il montaggio a incasso in mobili per ufficio e per la casa, con sicurezza integrata per i bambini.

Verbinder und Tülle für die Unterputzmontage in Büro- und Wohnmöbeln, mit integrierter Kindersicherung.



Sono progettate per ricaricare dispositivi elettronici come tablet o telefoni cellulari in modo semplice e discreto.

Sie sind so konzipiert, dass sie elektronische Geräte wie Tablets oder Mobiltelefone einfach und diskret aufladen.

## Connettore e passacavo Circle 80 (Ø80mm) Steckverbinder und Tülle Circle 80 (Ø80mm)



Potenza/Leistung	Finitura/Fertigstellung	Imballaggio/Verpackung	Cod.
USB A - DC 5V-2.1A (10.5W) USB C - DC 5V-2.1A (10.5W)	Verniciato nero/Schwarz	1 UN/Einh	5048414

Tecnoplastica/Kunststoff

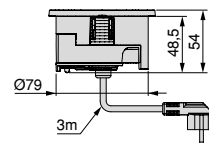
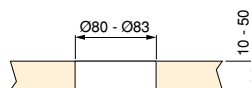
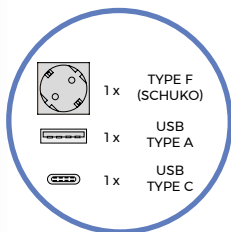

**Multiconnettore Vertikal Push 60 (Ø60mm)**  
**Mehrfach-Steckerleiste Vertikal Push-to-Open 60 (Ø60mm)**



Potenza/Leistung	Finitura/Fertigstellung	Imballaggio/Verpackung	Cod.
USB A - DC 5V-2.4A (12W)	Acciaio inossidabile/Edelstahl	1 UN/Einh	5048165

Acciaio, Tecnoplastica/Kunststoff, Stahl

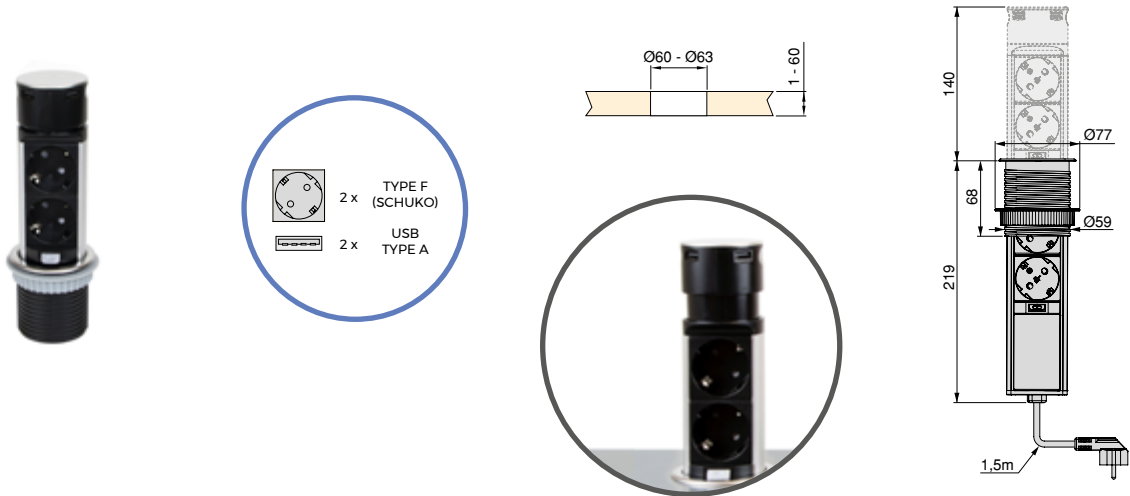

**Multiconnettore estraibile Vertikal (Ø60mm)**  
**Mehrfach-Steckerleiste anhebbar Vertikal (Ø60mm)**



Descrizioni/Beschreibung	Potenza/Leistung	Finitura/Fertigstellung	Imballaggio/Verpackung	Cod.
3 spine EU, 2 connettori USB A e 1 connettore USB C/3 Stecker, 2 USB-A-Stecker und 1 USB-C-Stecker	USB A - DC 5V-3A / 9V-2A / 12V-1.5A USB C - DC 5V-3A / 9V-2.22A / 12V-1.67A	Verniciato alluminio/Grau metallic	1 UN/Einh	5014425
3 spine EU e 2 connettori USB/ 3 Stecker und 2 USB-Anschlüsse	USB A - DC 5V-2A (10W)	Verniciato bianco/Weiß	1 UN/Einh	5009912
3 spine EU e 2 connettori USB/ 3 Stecker und 2 USB-Anschlüsse	USB A - DC 5V-2A (10W)	Verniciato alluminio/Grau metallic	1 UN/Einh	5009925
3 spine EU e 2 connettori USB/ 3 Stecker und 2 USB-Anschlüsse	USB A - DC 5V-2A (10W)	Verniciato nero/Schwarz	1 UN/Einh	5009914

Alluminio, Tecnoplastica/Aluminium, Kunststoff

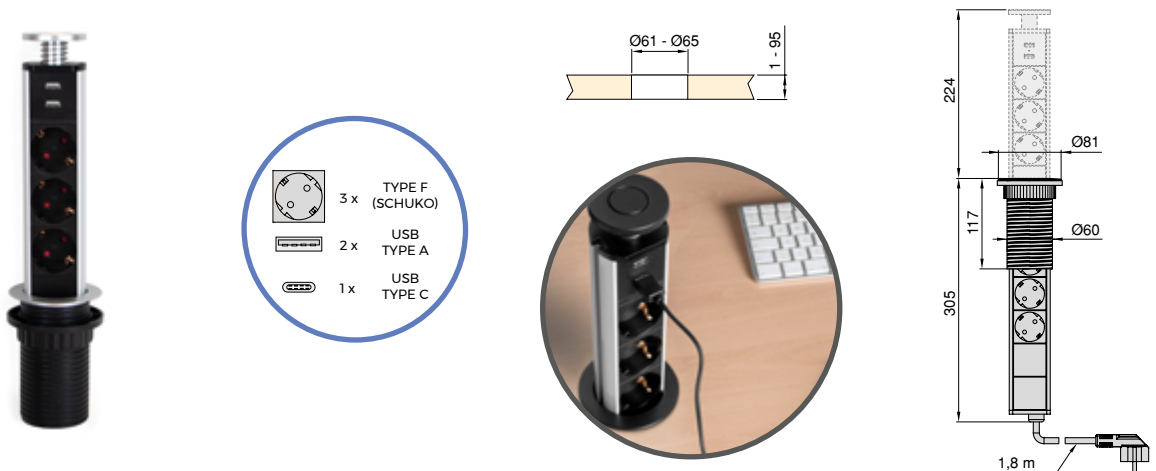

**Multiconnettore estraibile Port USB (Ø100mm)**  
**Mehrfach-Steckerleiste anhebbar Port USB (Ø100mm)**



Potenza/Leistung	Finitura/Fertigstellung	Imballaggio/Verpackung	Cod.
USB A - DC 5V-2.1A (10.5W)	Anodizzato opaco/Matt eloxiert	1 UN/Einh	5048762

Alluminio, Tecnoplastica/Aluminium, Kunststoff

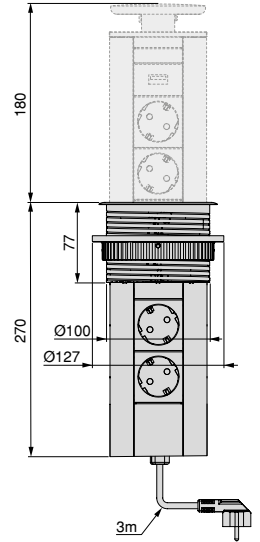
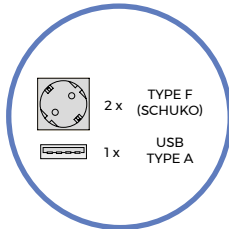

**Multiconnettore Vertikal Push 100 (Ø100mm)**  
**Mehrfach-Steckerleiste Vertikal Push-to-Open 100 (Ø100mm)**



Potenza/Leistung	Finitura/Fertigstellung	Imballaggio/Verpackung	Cod.
USB A - DC 5V-2.4A (12W)	Verniciato nero/Schwarz	1 UN/Einh	5048214

Acciaio, Tecnoplastica/Kunststoff, Stahl

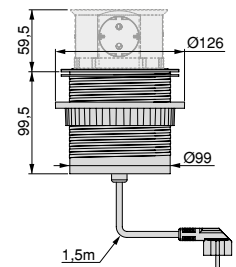
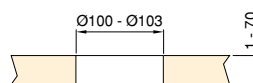
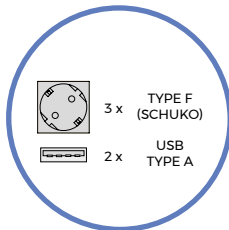

**Multipresa Atom 14 per scrivania (130x115mm)**  
**Mehrfach-Steckerleiste Atom 14 für Tische (130x115mm)**



Potenza/Leistung	Finitura/Fertigstellung	Imballaggio/Verpackung	Cod.
USB A - DC 5V-2.1A (10.5W)	Verniciato nero/Schwarz	1 UN/Einh	5029714
USB A - DC 5V-2.1A (10.5W)	Verniciato alluminio/Grau metallic	1 UN/Einh	5029725

Acciaio, Alluminio, Tecnoplastica/Aluminium, Kunststoff, Stahl

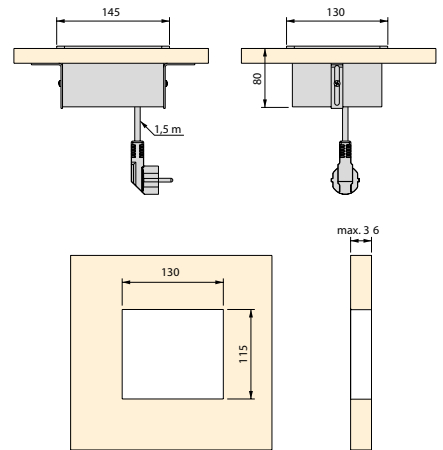
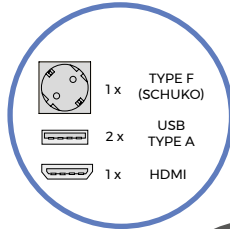

**Multiconnettore superficie V Dock per mobili**  
**Mehrfach-Steckerleiste V Dock für Möbel**



Finitura/Fertigstellung	Imballaggio/Verpackung	Cod.
Anodizzato opaco/Matt eloxiert	1 UN/Einh	5048862

Alluminio, Tecnoplastica/Aluminium, Kunststoff

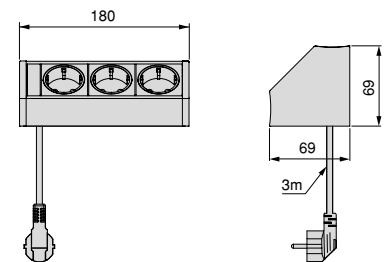
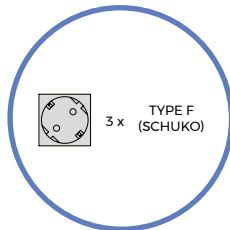



## Connettori Anschlüsse

Base multipla con elegante finitura in acciaio inox che consente la completa integrazione a filo nei mobili di cucina, ufficio e casa.

Mehrfachsteckdose in eleganter Edelstahloptik, die sich vollständig in Küchen-, Büro- und Wohnmöbel integrieren lässt.



Il suo design innovativo permette di nascondere le prese quando non sono in uso e, con un leggero tocco, di ruotarle per accedere alle prese.

Das innovative Design sorgt dafür, dass die Steckdosen nicht sichtbar sind, wenn sie nicht gebraucht werden, und lässt sich mit einer leichten Berührung schwenken, um an die Steckdosen zu gelangen.

### Multipresa Backflip per scrivania (215x88mm)

### Mehrfach-Steckerleiste Backflip für Tische (215x88mm)



Potenza/Leistung	Finitura/Fertigstellung	Imballaggio/Verpackung	Cod.
USB A - DC 5V-2.1A (10.5W)	Acciaio inossidabile/Edelstahl	1 UN/Einh	5048565

Acciaio, Tecnoplastica/Kunststoff, Stahl

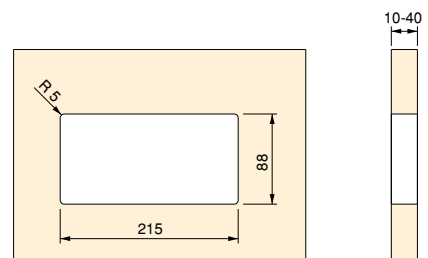
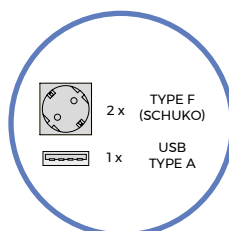
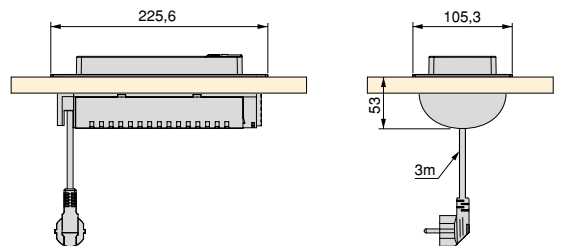

**Multipresa Atom 26 per scrivania (225x111mm)**  
**Mehrfach-Steckerleiste Atom 26 für Tische (225x111mm)**

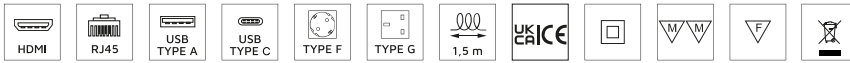

Potenza/Leistung	Finitura/Fertigstellung	Imballaggio/Verpackung	Cod.
USB A - DC 5V-3A / 9V-2A / 12V-1.5A - USB C - DC 5V-3A / 9V-2A / 12V-1.5A	Verniciato nero/Schwarz	1 UN/Einh	5039914
USB A - DC 5V-3A / 9V-2A / 12V-1.5A - USB C - DC 5V-3A / 9V-2A / 12V-1.5A	Verniciato bianco/Weiß	1 UN/Einh	5039912
USB A - DC 5V-3A / 9V-2A / 12V-1.5A - USB C - DC 5V-3A / 9V-2A / 12V-1.5A	Verniciato alluminio/Grau metallic	1 UN/Einh	5039925

Acciaio, Tecnoplastica, Zama/Kunststoff, Stahl, Zamak

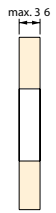
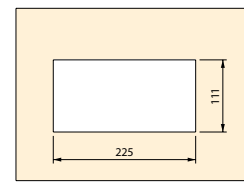
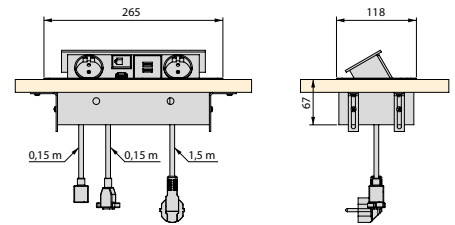
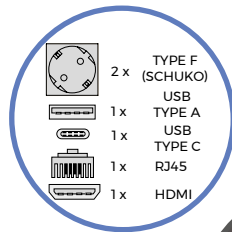

**Multipresa Atom 26 Lite per scrivania (225x111mm)**  
**Mehrfach-Steckerleiste Atom 26 Lite für Tische (225x111mm)**



Potenza/Leistung	Finitura/Fertigstellung	Imballaggio/Verpackung	Cod.
USB A - DC 5V-2.1A (10.5W) - USB C - DC 5V-2.1A (10.5W)	Verniciato bianco/Weiß	1 UN/Einh	5039812
USB A - DC 5V-2.1A (10.5W) - USB C - DC 5V-2.1A (10.5W)	Verniciato nero/Schwarz	1 UN/Einh	5039814
USB A - DC 5V-2.1A (10.5W) - USB C - DC 5V-2.1A (10.5W)	Verniciato alluminio/Grau metallic	1 UN/Einh	5039825

Acciaio, Tecnoplastica, Zama/Kunststoff, Stahl, Zamak

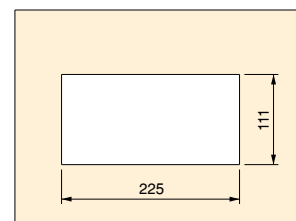
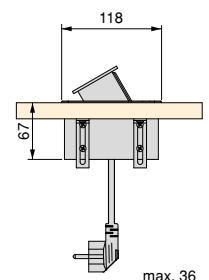
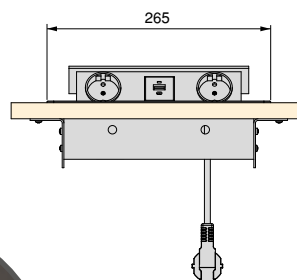
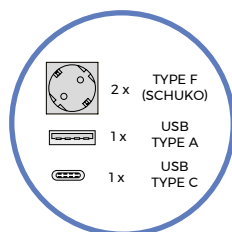

## Accessori per ufficio Büro-Accessoires

Per creare spazi di lavoro confortevoli sono necessari alcuni accessori essenziali per l'ufficio che aggiungono funzionalità ai mobili.

Um einen komfortablen Arbeitsplatz zu schaffen, benötigen Sie einige wichtige Accessoires für Ihr Büro, die die Funktionalität Ihrer Möbel erhöhen.



Con una semplice lavorazione, grazie alla nostra gamma di passacavi avrete sempre i cavi organizzati.

Dank unserer Kabeldurchführungstüllen können Sie mit einer einfachen Bearbeitung Ihre Kabel stets in Ordnung halten.

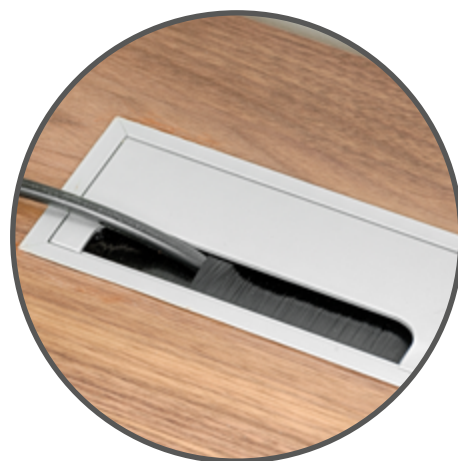





I passacavi sono progettati per mantenere i cavi organizzati sotto la scrivania dell'ufficio ed evitare che si aggroviglino.

Die Kabeldurchführungen sorgen für Ordnung unter dem Schreibtisch und verhindern, dass sich die Kabel verheddern.



Passacavi Circum (Ø60mm, Ø80mm)  
Kabeldurchlass rund Circum (Ø60mm, Ø80mm)

A	Diametro/Durchmesser	Finitura/Fertigstellung	Imballaggio/Verpackung	Cod.
68,5	60	Cromato lucido/Verchromt 	8 UN/Einh	5006711
90	80	Cromato lucido/Verchromt 	7 UN/Einh	5022511
68,5	60	Cromo opaco/Matt verchromt 	8 UN/Einh	5006764
90	80	Cromo opaco/Matt verchromt 	7 UN/Einh	5022564

Zama/Zamak

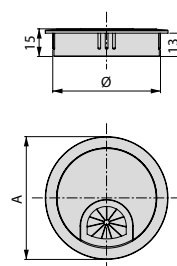
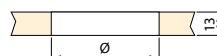

Passacavi da tavolo (Ø60mm, Ø80mm)  
Kabeldurchlass rund (Ø60mm, Ø80mm)

A	B	Diametro/Durchmesser	Finitura/Fertigstellung	Imballaggio/Verpackung	Cod.
71	14	60	Plastica bianca/Weißer Kunststoff 	100 UN/Einh	5123815
95	20	80	Plastica bianca/Weißer Kunststoff 	100 UN/Einh	5123915
71	14	60	Plastica nera/Schwarzer Kunststoff 	100 UN/Einh	5123817
95	20	80	Plastica nera/Schwarzer Kunststoff 	100 UN/Einh	5123917
71	14	60	Plastica grigia/Grau 	100 UN/Einh	5123821
95	20	80	Plastica grigia/Grau 	100 UN/Einh	5123921

Tecnoplastica/Kunststoff

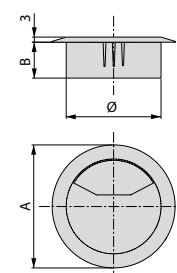
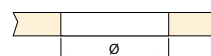

**Passacavi da tavolo Quadrum, rettangolare (159x80mm, 269x80mm)**  
**Kabeldurchlass Quadrum für Tisch, rechteckig (159x80mm, 269x80mm)**

A	B	Finitura/Fertigstellung	Imballaggio/Verpackung	Cod.
159	147	Anodizzato opaco/Matt eloxiert	5 UN/Einh	5010062
269	257	Anodizzato opaco/Matt eloxiert	5 UN/Einh	5012462

Alluminio/Aluminium

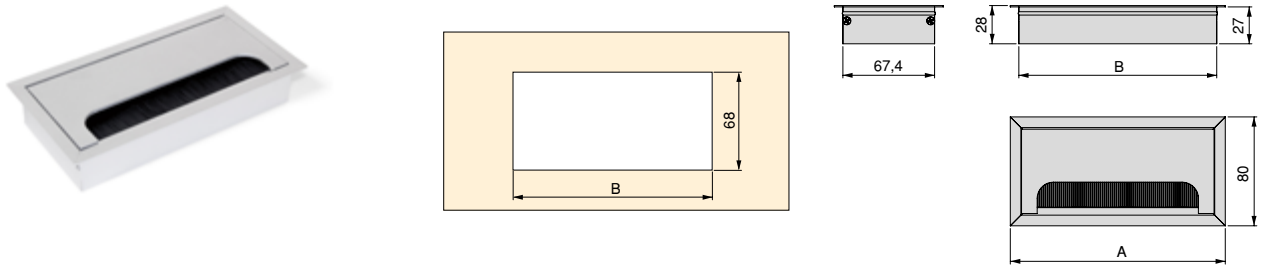

**Passacavi da tavolo Plaswire 85 (78x78mm)**  
**Kabeldurchlass Plaswire 85 für Tische (78x78mm)**

Finitura/Fertigstellung	Imballaggio/Verpackung	Cod.
Verniciato bianco/Weiß	15 UN/Einh	5012512
Verniciato nero/Schwarz	15 UN/Einh	5012514

Tecnoplastica/Kunststoff

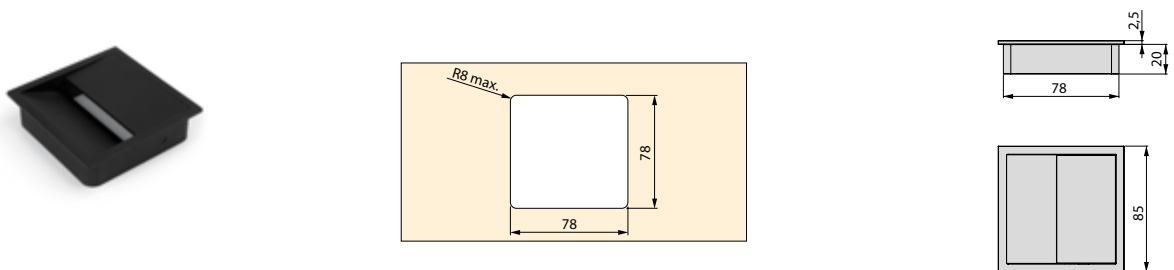

**Passacavi da tavolo Plaswire 152 (146x56mm)**  
**Kabeldurchlass Plaswire 152 für Tische (146x56mm)**

Finitura/Fertigstellung	Imballaggio/Verpackung	Cod.
Verniciato bianco/Weiß	10 UN/Einh	5012612
Verniciato nero/Schwarz	10 UN/Einh	5012614

Tecnoplastica/Kunststoff

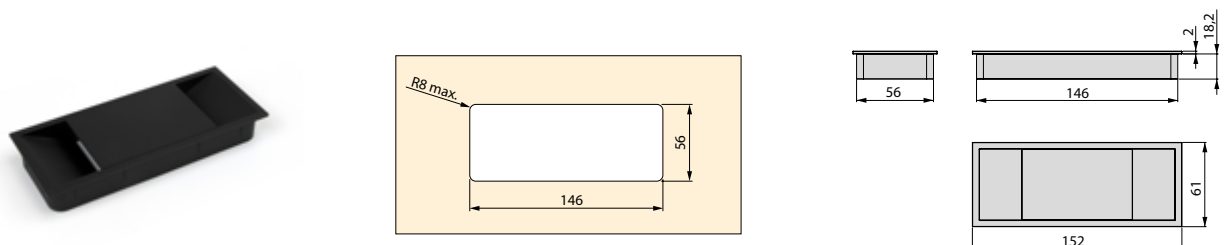

Colonna passacavi Pipe 4  
Kabeldurchlass Pipe 4

Finitura/Fertigstellung	Imballaggio/Verpackung	Cod.
Verniciato alluminio/Grau metallic 	10 UN/Einh	6210025

Tecnoplastica/Kunststoff

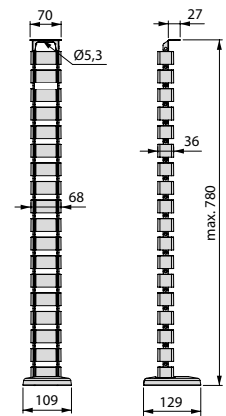
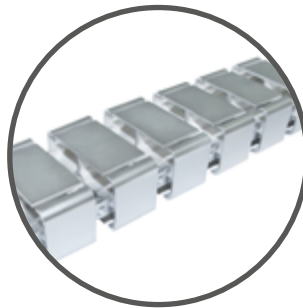

Colonna passacavi Hexa  
Kabeldurchlass Hexa

Finitura/Fertigstellung	Imballaggio/Verpackung	Cod.
Plastica nera/Schwarzer Kunststoff 	1 UN/Einh	3025917

Tecnoplastica/Kunststoff

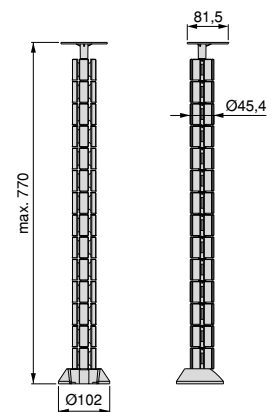

Supporti per monitor inclinabili e girevole a 360° per tavolo.  
Kipp- und drehbare 360°-Monitorständer für Tisch



Descrizioni/Beschreibung	Finitura/Fertigstellung	Imballaggio/Verpackung	Cod.
Semplice/Einfach	Verniciato nero/Schwarz	1 UN/Einh	3200014
Doppio/Doppelt	Verniciato nero/Schwarz	1 UN/Einh	3200114

Acciaio/Stahl

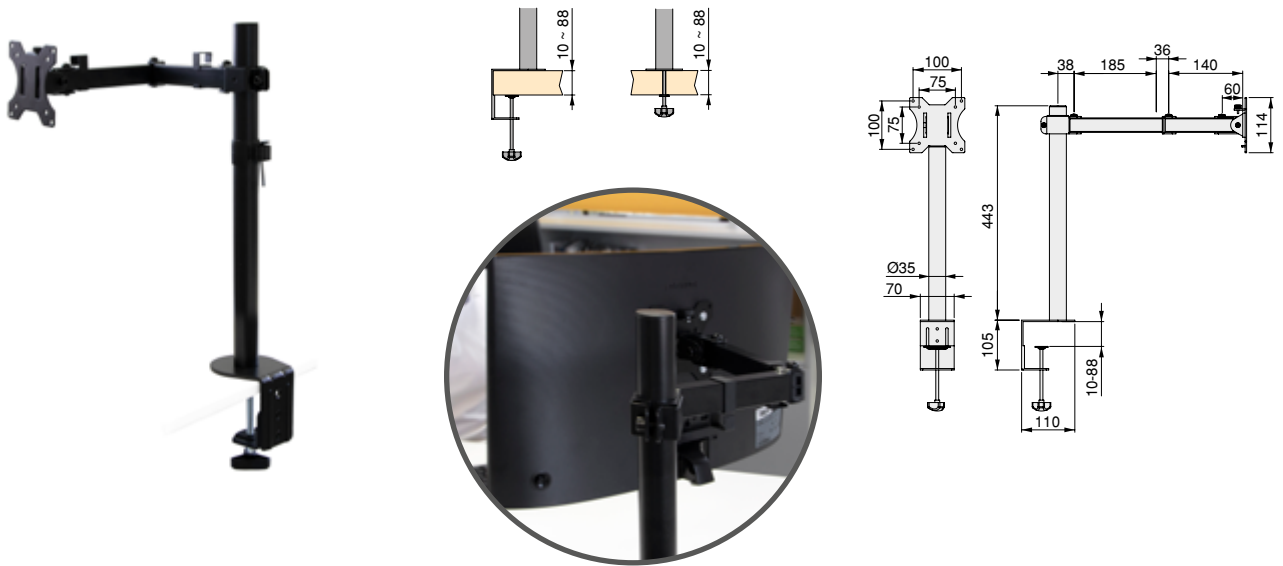

Supporto CPU  
Halterung für CPU



Finitura/Fertigstellung	Imballaggio/Verpackung	Cod.
Verniciato alluminio/Grau metallic	1 UN/Einh	6216925

Acciaio/Stahl



**Base girevole Giro 4**  
**Drehunterlage Giro 4**



Finitura/Fertigstellung	Imballaggio/Verpackung	Cod.
Zincato bianco/Verzinkt	10 UN/Einh	3198305

Acciaio/Stahl

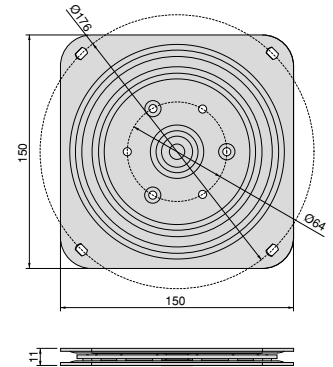
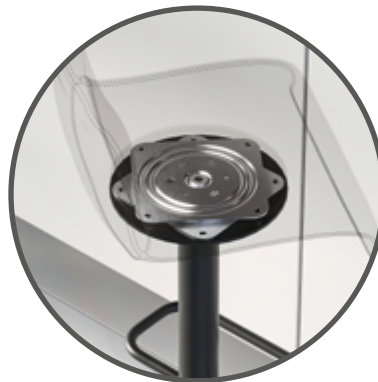
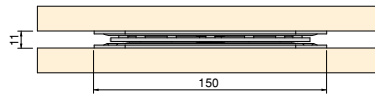

**Base girevole Giro 1**  
**Drehunterlage TV Giro 1**



Finitura/Fertigstellung	Imballaggio/Verpackung	Cod.
Verniciato nero/Schwarz	20 UN/Einh	4952614

Acciaio/Stahl

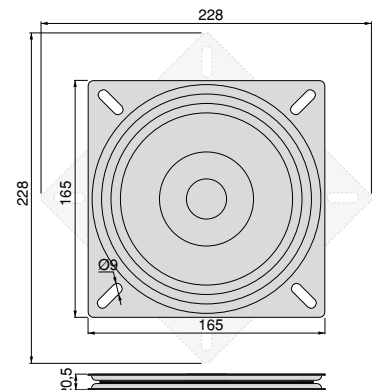
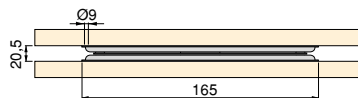



**Guida portatastiera a rotelle in acciaio**  
**Satz Rollenführungen für Tasatur, Stahl**

Finitura/Fertigstellung	Imballaggio/Verpackung	Cod.
Verniciato alluminio/Grau metallic 	1 SET/Satz	3026025

Acciaio/Stahl

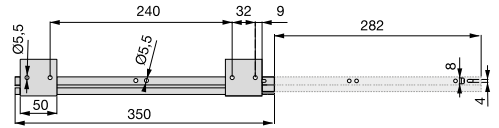
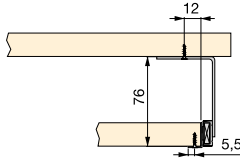

**Guida porta tastiera con sfere in acciaio**  
**Satz Kugelführungen für Taststurauszug aus Stahl**



Finitura/Fertigstellung	Imballaggio/Verpackung	Cod.
Zincato nero/Schwarz verzinkt 	20 UN/Einh	4193409

Acciaio/Stahl

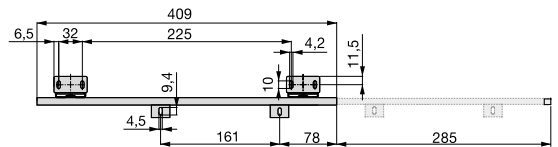
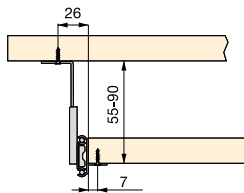

**Porta tastiera Mickey2**  
**Tastaturauszug Mickey2**

Finitura/Fertigstellung	Imballaggio/Verpackung	Cod.
Plastica grigia/Grau 	5 UN/Einh	4193121

Acciaio, Tecnoplastica/Kunststoff, Stahl

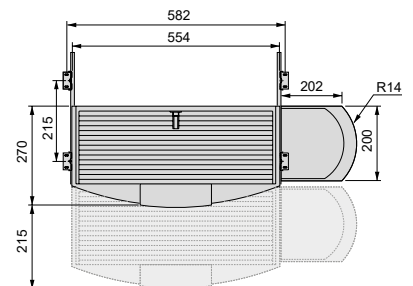
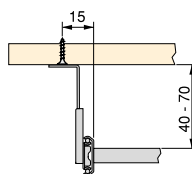

Supporto automatico per televisione Lift - Vision  
TV-Lift Vision



Finitura/Fertigstellung	Imballaggio/Verpackung	Cod.
Verniciato nero/Schwarz 	1 UN/Einh	6009814

Acciaio/Stahl

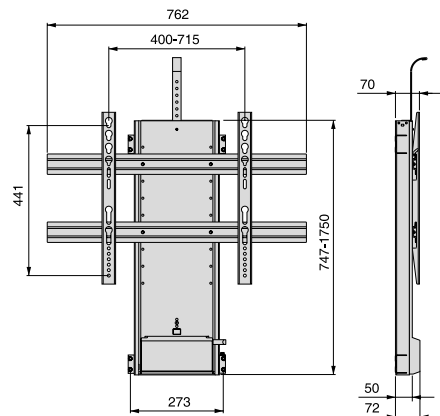
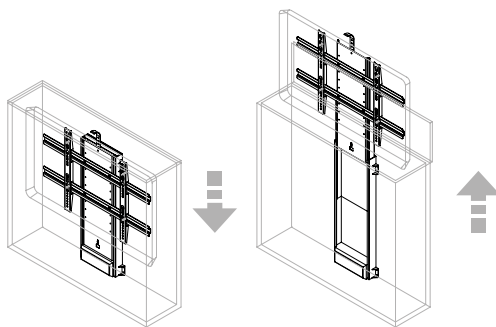

- Supporto motorizzato per televisioni.
- Corsa del supporto fino ad un metro.
- Comprende interruttore manuale ad incasso e telecomando a distanza a radio frequenza.
- Alimentazione 110-240V AC / 50-60Hz.
- Comprende adattatore tipo G per UK.
- Dispositivo di sicurezza con ritorno in discesa per evitare impigliamento.
- Fine corsa regolabile in discesa.
- Supporto peso: minimo 5 Kg, massimo 100 Kg.
- Compatibili con agganci televisori VESA: 200x100 - 200x200 - 300x300 - 400x100 400x200 - 400x400 - 600x100 - 600x200 - 600x400.

- Motorisierte Hebehilfe für Fernseher.
- Route der Stütze bis zu einem Meter.
- Hat einen manuellen Schalter, der in den Schrank eingestellt werden kann, und eine funkgesteuerte Fernbedienung.
- Es ist eine Stromversorgung von 110-240 VAC / 50-60 Hz erforderlich.
- Enthält einen Adapter vom Typ G (UK).
- Ein Rückstoß-Sicherheitsmechanismus ist vorhanden, um zu verhindern, dass beim Absenken des Fernsehgeräts etwas hängen bleibt.
- Ende des einstellbaren Rennens in der Piste.
- Belastungen von mindestens 5 kg bis maximal 100 kg.
- Kompatibel mit Fernsehgeräten VESA: 200 x 100 - 200 x 200 - 300 x 300 - 400 x 100 - 400 x 200 - 400 x 400 - 600 x 100 - 600 x 200 - 600 x 400.