



Plasline & Sink

SOCLE ET PROTECTEURS FOND
PLINTHS AND BASE PLATE PROTECTORS

Accessoires pour les meubles de la cuisine Accessories for kitchen furniture

Revêtement pour le bas des modules dans les meubles de cuisine, pour protéger l'intérieur du meuble contre l'humidité et les éclaboussures éventuelles.

Fabriqué en plastique avec une haute résistance à la corrosion et fini en gris anthracite.

A protector for the bottom of low modules in kitchen furniture, designed to safeguard the interior of the cabinet from potential dampness and splashes.

Crafted from plastic with high resistance to corrosion and finished in anthracite gray.

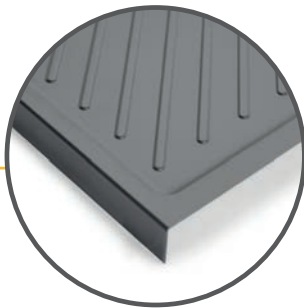

Conçu pour s'adapter aux modules bas standard d'une profondeur de 580 mm et d'une épaisseur de 16 mm. Facilement ajustable pour s'adapter aux modules ayant une profondeur minimale de 490 mm ou des épaisseurs de 18 mm et 19 mm.

Designed for standard low modules with a depth of 580mm and a thickness of 16mm. Easily trimmable to fit modules with a minimum depth of 490mm or thicknesses of 18mm and 19mm.

PROTECTEURS FOND CAISSON / MODULE BASE PLATE PROTECTORS

Protecteurs fond pour la cuisine Sink
Shelf liner for kitchen cabinets Sink

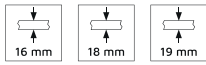

M	A	B	Finition/Finishing	Emballage/Packaging	Cod.
450	417	387	Gris antracite/Anthracite grey	■	20 U/Unit 8478023
500	467	442	Gris antracite/Anthracite grey	■	20 U/Unit 8478123
600	567	542	Gris antracite/Anthracite grey	■	20 U/Unit 8478223
800	767	742	Gris antracite/Anthracite grey	■	20 U/Unit 8478323
900	867	842	Gris antracite/Anthracite grey	■	20 U/Unit 8478423
1.000	967	942	Gris antracite/Anthracite grey	■	20 U/Unit 8478523
1.200	1.167	1.142	Gris antracite/Anthracite grey	■	20 U/Unit 8478623

Plastique/Plastic

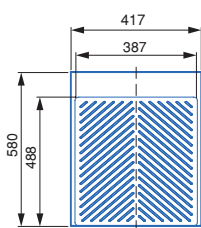
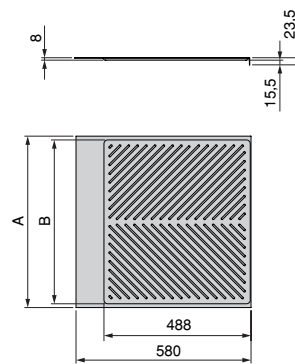
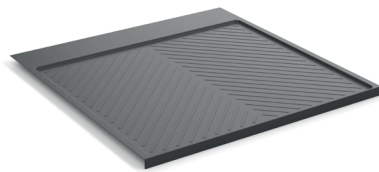

M45

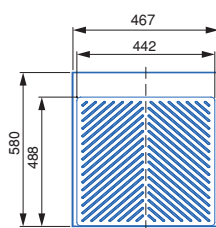

M50

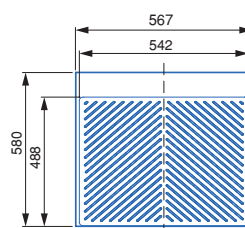

M60

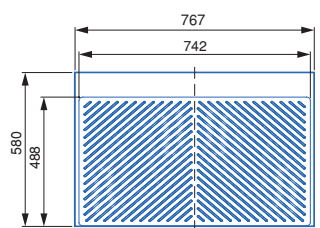

M80

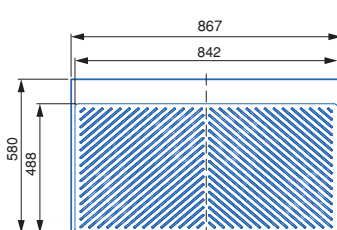

M90

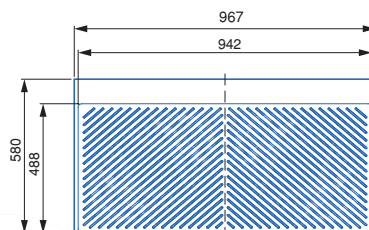

M100

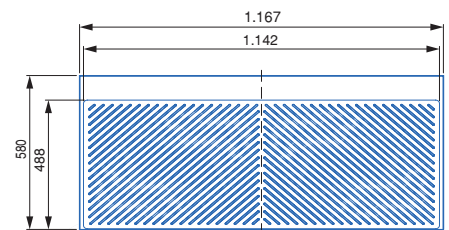

M120

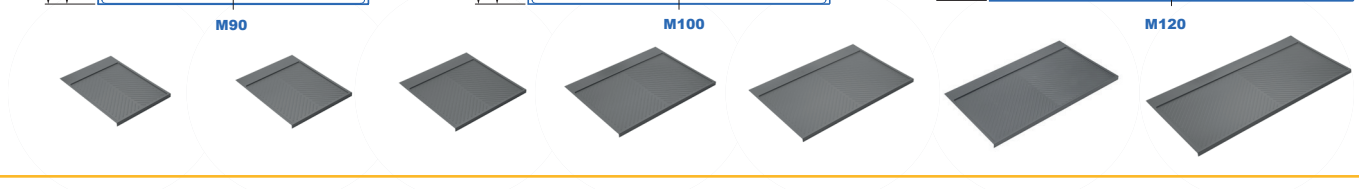

Plinthes et accessoires Plinth and accessories

Plinthes de cuisine conçues pour protéger les meubles bas de la cuisine contre les dommages et l'infiltration de liquides et de poussière dans l'espace entre les armoires et le sol, disponibles en différentes hauteurs de plinthes et finitions variées.

Kitchen skirting boards designed to protect lower kitchen cabinets from damage and the infiltration of liquids and dust into the gap between cabinets and the floor, available in various heights and finishes.

Plinthe et profilé de poignée supérieur dans une finition noire.

Plinth and upper Gola profile in black finish.





Les plinthes Plasline sont des profils décoratifs en PVC de haute qualité. Leur structure interne, avec de nombreuses nervures de renforcement, leur confère une grande rigidité. De plus, ils disposent d'une languette inférieure flexible qui assure un contact total avec le sol et empêche le passage des liquides et de la poussière au fond du meuble.

Plasline plinths are decorative profiles made of high-quality PVC. Their internal structure, with numerous reinforcing ribs, provides them with great rigidity. Moreover, they feature a flexible lower tongue that ensures total contact with the floor and prevents the passage of liquids and dust to the bottom of the furniture.

Finitions disponibles.





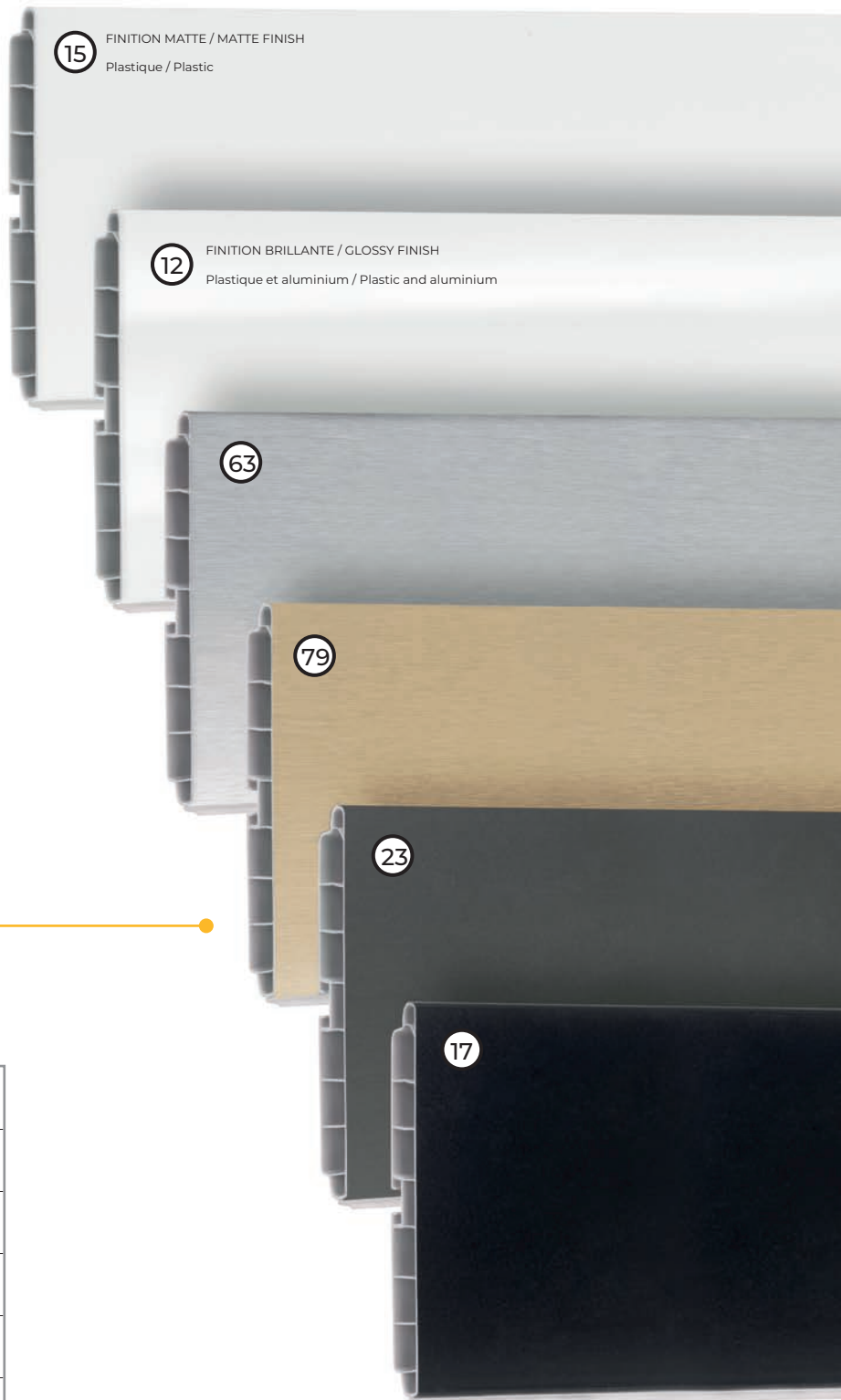







Available finishes.

15	Blanc/White
12	Peint en blanc/White painted
63	Anodisé satiné/Satin anodized
79	Or/Gold
23	Gris anthracite/Anthracite gray
17	Noir/Black



Socles Plasline

Plasline plinth for kitchen

Hauteur/Height	Longueur/Longitude	Finition/Finishing		Emballage/Packaging	Cod.
100	3,9 m	Peint en blanc/White painted		10 U/Unit	8060112
150	2,35 m	Peint en blanc/White painted		15 U/Unit	8060512
150	3,9 m	Peint en blanc/White painted		10 U/Unit	8060312
100	3,9 m	Blanc/White		10 U/Unit	8060115
120	3,9 m	Blanc/White		10 U/Unit	8060215
150	3,9 m	Blanc/White		10 U/Unit	8060315
100	3,9 m	Noir/Black		10 U/Unit	8060117
120	3,9 m	Noir/Black		10 U/Unit	8060217
150	3,9 m	Noir/Black		10 U/Unit	8060317
100	3,9 m	Gris antracite/Anthracite grey		10 U/Unit	8060123
150	3,9 m	Gris antracite/Anthracite grey		10 U/Unit	8060323
100	2,35 m	Anodisé satiné/Satin finished anodized		15 U/Unit	8060463
100	3,9 m	Anodisé satiné/Satin finished anodized		10 U/Unit	8060163
120	3,9 m	Anodisé satiné/Satin finished anodized		10 U/Unit	8060263
150	2,35 m	Anodisé satiné/Satin finished anodized		15 U/Unit	8060563
150	3,9 m	Anodisé satiné/Satin finished anodized		10 U/Unit	8060363
165	3,9 m	Anodisé satiné/Satin finished anodized		10 U/Unit	8061063
180	3,9 m	Anodisé satiné/Satin finished anodized		10 U/Unit	8913063
100	3,9 m	Or/Gold		10 UN/UN	8060179
120	3,9 m	Or/Gold		10 UN/UN	8060279
150	3,9 m	Or/Gold		10 UN/UN	8060379

Aluminium, Plastique/Aluminium, Plastic

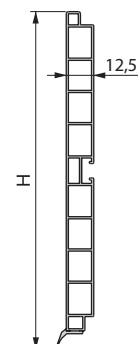
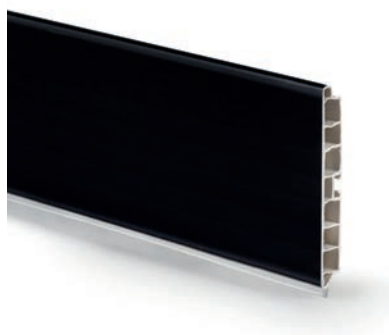

Angles flexibles Plasline
 Plinth with Plasline flexible angles

Hauteur/Height	Finition/Finishing		Emballage/Packaging	Cod.
100	Peint en blanc/White painted		20 U/Unit	8910112
150	Peint en blanc/White painted		20 U/Unit	8910312
100	Blanc/White		20 U/Unit	8910115
120	Blanc/White		20 U/Unit	8910215
150	Blanc/White		20 U/Unit	8910315
100	Noir/Black		20 U/Unit	8910117
150	Noir/Black		20 U/Unit	8910317
120	Noir/Black		20 U/Unit	8910217
100	Gris antracite/Anthracite grey		20 U/Unit	8910123
150	Gris antracite/Anthracite grey		20 U/Unit	8910323
100	Anodisé satiné/Satin finished anodized		20 U/Unit	8910163
120	Anodisé satiné/Satin finished anodized		20 U/Unit	8910263
150	Anodisé satiné/Satin finished anodized		20 U/Unit	8910363
165	Anodisé satiné/Satin finished anodized		20 U/Unit	8910463
180	Anodisé satiné/Satin finished anodized		20 U/Unit	8910563
100	Or/Gold		20 U/Unit	8910179
120	Or/Gold		20 U/Unit	8910279
150	Or/Gold		20 U/Unit	8910379

Aluminium, Plastique/Aluminium, Plastic

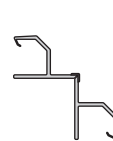
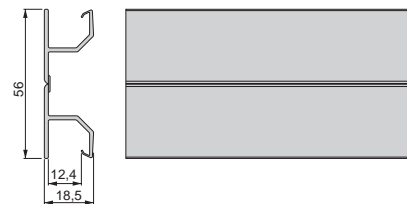

- 90°

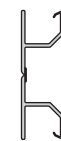







180°



+ 90°

Angles de 90° Plasline
 Plinth with Plasline 90° angles

Hauteur/Height	Finition/Finishing	Emballage/Packaging	Cod.
100	Gris antracite/Anthracite grey 	20 U/Unit	8011623
150	Gris antracite/Anthracite grey 	20 U/Unit	8015623
100	Anodisé satiné/Satin finished anodized 	20 U/Unit	8011663
120	Anodisé satiné/Satin finished anodized 	20 U/Unit	8013563
150	Anodisé satiné/Satin finished anodized 	20 U/Unit	8015663
165	Anodisé satiné/Satin finished anodized 	20 U/Unit	8919463
180	Anodisé satiné/Satin finished anodized 	20 U/Unit	8913163

Aluminium, Plastique/Aluminium, Plastic

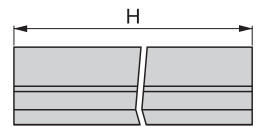
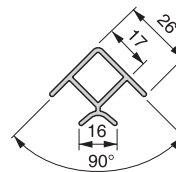



Rallonges Plasline
 Plasline extension

Hauteur/Height	Finition/Finishing	Emballage/Packaging	Cod.
150	Anodisé satiné/Satin finished anodized 	20 U/Unit	8060963

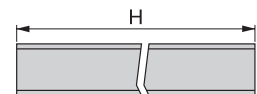
Aluminium, Plastique/Aluminium, Plastic



Kit de plinthes de cuisine Plasline avec accessoires union
 Plasline Kitchen plinth kit with union accessories

Hauteur/Height	Longueur/Longitude	Finition/Finishing	Emballage/Packaging	N° partie/N° pieces	Cod.
100	2,35 m	Noir/Black	 1 LT/LOT	2 unités/2 units	8952417
150	2,35 m	Noir/Black	 1 LT/LOT	2 unités/2 units	8952517
100	2,35 m	Anodisé satiné/Satin finished anodized	 1 LT/LOT	2 unités/2 units	8952463
150	2,35 m	Anodisé satiné/Satin finished anodized	 1 LT/LOT	2 unités/2 units	8952563

Plastique/Plastic

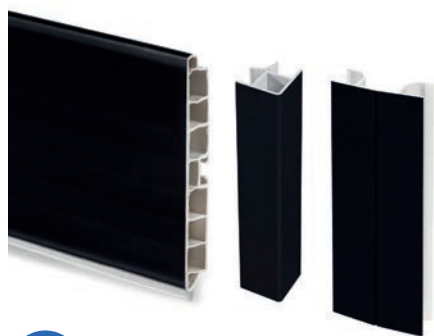

KITS

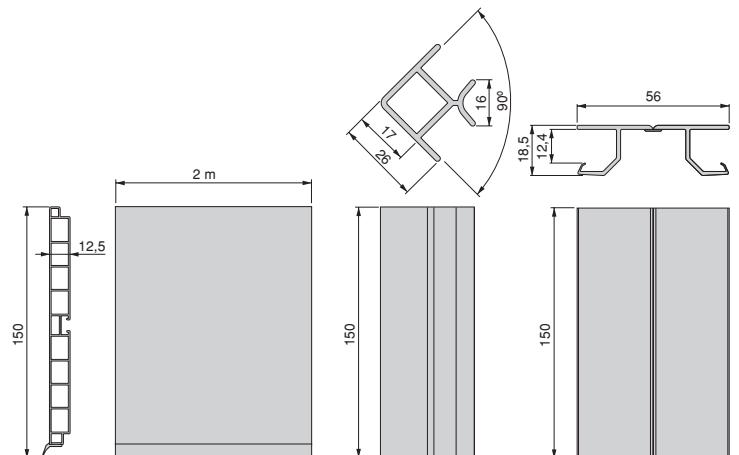



Emuca S.R.L

Via Messico, 80 · 35127 · Padova (ITALIA)
T. +39 049 8702800 · F. +39 049 87 03019
www.emuca.it

Emuca S.A.

Pl. El Oliveral - c/H, 4 · Apartado de correos 176
46394 · Riba-Roja del Túria · Valencia (ESPAÑA)
T. +34 96 166 70 19 · F. +34 96 166 71 82
www.emuca.es

Emuca Ltd.

75 Springfield Road · Chelmsford · Essex
CM2 6JG (UK)
T. +44 1268 530 674 · F. +44 1268 282 592
www.emuca.co.uk

Emuca S.A.R.L

Parc de l'Aubinière · 2 Avenue des Améthystes
44338 · Nantes Cedex 03 (FRANCE)
T. +33 2 49 88 07 35 · F. +33 2 72 22 02 24
www.emuca.fr

Emuca Lda.

AV. da Liberdade n° 38, 4° · 1250-145 Lisboa (PORTUGAL)
T. +351 211 203 940 · F. +34 96 166 71 82
www.emuca.pt

04/2024

AENOR



Empresa
Registrada
UNE-EN ISO 9001
ER-0896/1999



UNI EN ISO 9001:2015



CERTIQUALITY
È MEMBRO DELLA
FEDERAZIONE CISQ

